



REPUBLIC OF THE PHILIPPINES  
**NATIONAL POWER CORPORATION**  
(Pambansang Korporasyon sa Elektrisidad)

## **TERMS OF REFERENCE**

Name of Project : **REHABILITATION/RESTORATION OF DAM INSTRUMENTATIONS OF ANGAT DAM MAIN AND SECONDARY DYKES LOCATED IN SAN LORENZO, NORZAGARAY, BULACAN**

Project Location : **ANGAT DAM, SAN LORENZO, BULACAN**

Specification No : **PR No. HO-DRW23-007**

Contents :

- SECTION I - INSTRUCTIONS TO BIDDERS**
- SECTION II - GENERAL CONDITIONS OF CONTRACT**
- SECTION III - TECHNICAL SPECIFICATIONS**
  - PART I – TECHNICAL SPECIFICATIONS**
  - PART II – TECHNICAL DATA SHEETS**
- SECTION IV - SCHEDULE OF REQUIREMENTS**
- SECTION V - BIDDING FORMS**
- SECTION VI - REFERENCE DRAWINGS**

**Design and Development Department**



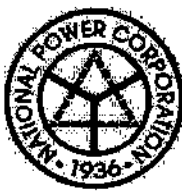

# National Power Corporation

## NEGOTIATED PROCUREMENT

### NP 2024-0018

1. The NATIONAL POWER CORPORATION (NPC), through its approved Corporate Budget of CY 2024 intends to apply the sum of (Please see schedule below) being the Approved Budget for the Contract (ABC) to payments under the contract. Bids received in excess of the ABC shall be automatically rejected at Bid opening.

PR Nos./PB Ref No. & Description	Similar Contracts	Pre-Nego Conference	Bid Submission / Opening	ABC
HO-DRW23-007 / PB240227-RA00069 (NP2)  Rehabilitation / Restorations of Dam Instrumentations of Angat Dam Main and Secondary Dykes at San Lorenzo, Norzagaray, Bulacan	Supply and Delivery or Restoration of Strong Motion Accelerometers / Standpipe Piezometer / Dam Instrumentations	24 June 2024 9:30 AM	25 June 2024 9:30 AM	₱ 1,048,000.00
<b>Venue: Kañao Function Room, NPC Bldg. Diliman, Quezon City</b>				

2. The NPC now invites Bids for Items listed above. Delivery of the items is required within (see table below) in the Technical Specifications in the Terms of Reference. Bidders should have completed from the date of submission and receipt of bids, a contract similar to the Project., must be at least equivalent to an amount as stated in the Terms of Reference.

PR Nos./PB Ref Nos.	Delivery Period / Contract Duration	Relevant Period of SLCC reckoned from the date of submission & receipt of bids
HO-DRW23-007	Ninety (90) Calendar Days	-

3. Bidding will be conducted through Negotiated Procurement procedures using a non-discretionary "pass/fail" criterion as specified in the Implementing Rules and Regulations (IRR) of Republic Act (RA) 9184, otherwise known as the "Government Procurement Reform Act".
4. Interested bidders may obtain further information from BAC Secretariat at the address given below during office hours.
5. A complete set of TOR will be provided to the interested Bidders from the address below. It may also be downloaded from the websites of the Philippine Government Electronic Procurement System (PhilGEPS) <http://www.philgeps.gov.ph> and National Power Corporation <http://www.napocor.gov.ph>.
6. NPC will hold a Pre-Negotiation Conference on the date, time and venue stated above.

Only registered bidder/s shall be allowed to participate for the conduct of virtual pre-bid conference. **Unregistered bidders** may attend the Pre-Bid Conference at the Kañao Room, NPC subject to the following:

- a. Only a maximum of two (2) representatives from each bidder / company shall be allowed to participate.
- b. Wearing of Face Masks is recommended but not required in view of Proclamation No. 297 S.2023 lifting the State of Public Health Emergency Throughout the Philippines

- c. The requirements herein stated including the medium of submission shall be subject to GPPB Resolution No. 09-2020 dated 07 May 2 020
  - d. The Guidelines on the Implementation of Early Procurement Activities (EPA) shall be subject to GPPB Circular No. 06-2019 dated 17 July 2019
7. Bids must be delivered to the address below on the date stated above. Late bids shall not be accepted.
  8. NPC reserves the right to accept or reject any bid, to annul the bidding process, and to reject all bids at any time prior to the contract award, without thereby incurring any liability to the affected bidder or bidders.
  9. For further information, please refer to:

**Bids and Contracts Services Division,  
Logistics Department**  
Gabriel Y. Itchon Building  
Senator Miriam P. Defensor-Santiago Ave. (formerly BIR Road)  
Cor. Quezon Ave., Diliman, Quezon City, 1100  
Tel Nos.: 8921-3541 local 5564/5713  
Fax No.: 8922-1622  
Email: [bcسد@napocor.gov.ph](mailto:bcسد@napocor.gov.ph)



**ATTY. MELCHOR P. RIDULME**  
Senior Vice President and  
Chairman, Bids and Awards Committee

## **SECTION I**

# **INSTRUCTIONS TO BIDDERS**



**SECTION I – INSTRUCTIONS TO BIDDERS****TABLE OF CONTENTS**

<u>CLAUSE NO.</u>	<u>TITLE</u>	<u>PAGE NO.</u>
1.	SCOPE OF BID.....	1
2.	SOURCE OF FUNDS.....	1
3.	CORRUPT, FRAUDULENT, COLLUSIVE, AND COERCIVE PRACTICES .....	2
4.	CONFLICT OF INTEREST.....	3
5.	ELIGIBLE BIDDERS.....	4
6.	BIDDER'S RESPONSIBILITIES .....	6
7.	ORIGIN OF GOODS .....	8
8.	SUBCONTRACTS .....	8
9.	NEGOTIATION .....	8
10.	CLARIFICATION AND AMENDMENT OF TOR.....	8
11.	LANGUAGE OF BIDS .....	9
12.	DOCUMENTS COMPRISING THE BID: ELIGIBILITY AND TECHNICAL COMPONENTS.....	9
13.	DOCUMENTS COMPRISING THE BID: FINANCIAL COMPONENT .....	12
14.	ALTERNATIVE BIDS.....	12
15.	BID PRICES.....	12
16.	BID CURRENCIES.....	14
17.	BID VALIDITY .....	14
18.	FORMAT AND SIGNING OF BIDS.....	15
19.	SEALING AND MARKING OF BIDS .....	15
20.	DEADLINE FOR SUBMISSION OF BIDS .....	16
21.	OPENING AND PRELIMINARY EXAMINATION OF BIDS.....	16
22.	PROCESS TO BE CONFIDENTIAL .....	18
23.	CLARIFICATION OF BIDS.....	18
24.	DOMESTIC PREFERENCE.....	18
25.	DETAILED EVALUATION AND COMPARISON OF BIDS .....	19
26.	POST-QUALIFICATION .....	20
27.	RESERVATION CLAUSE.....	23
28.	CONTRACT AWARD .....	24
29.	SIGNING OF THE CONTRACT .....	25
30.	PERFORMANCE SECURITY .....	25
31.	NOTICE TO PROCEED .....	27
32.	PROTEST MECHANISM .....	27

## SECTION I – INSTRUCTIONS TO BIDDERS

### A. General

#### 1. Scope of Bid

1.1. The National Power Corporation (NPC) wishes to conduct the negotiated procurement for the **REHABILITATION / RESTORATION OF DAM INSTRUMENTATIONS OF ANGAT DAM MAIN AND SECONDARY DYKES LOCATED IN SAN LORENZO, NORZAGARAY, BULACAN (PR NO. HO-DRW23-007)** to selected Bidders in accordance with the revised IRR of R.A. 9184.

1.2. NPC's address is:

Office : **Bids and Contracts Services Division (BCSD)**  
Address : Ground Floor, Building No. 1  
National Power Corporation  
Gabriel Y. Itchon Building  
Sen. Miriam P. Defensor-Santiago Ave.,  
(formerly BIR Road) cor. Quezon Blvd.,  
Diliman, Quezon City, Metro Manila 1100  
Tel Nos. : 8924-52-11 and 8921-3541 Loc. 5564  
Tel/Fax No. : 8922-16-22  
Email : bcsd@napocor.gov.ph

1.3 For such purpose, the BAC may send its official letters/correspondences/notices through email. Upon securing the bidding documents, Bidders shall be required to indicate their official email and alternate email addresses. All letters/correspondences/notices sent by the BAC through the designated/official email shall be considered officially received by all bidders on the date indicated in National Power Corporation's sent folder.

1.4 Contract scope shall be as specified in the Technical Specifications and Bid Price Schedule. All appurtenances and associated supplies/works required to complete the works shall be deemed included in the scope of the contract.

1.5 The Goods are grouped together in one (1) lot and will be awarded to one (1) Bidder in one complete contract. Partial bid is not allowed. The Goods are grouped in a single lot and the lot shall not be divided into sub-lots for the purpose of bidding, evaluation, and contract award. The Bidders bid offer must be within the ABC of the lot. Bid offers that exceed the ABC of the lot or with incomplete price, shall be rejected.

#### 2. Source of Funds

2.1. The Funding Source is the Government of the Philippines (GOP) through the 2024 Corporate Budget of NPC, in the total amount of **ONE MILLION FORTY EIGHT THOUSAND PESOS (₱ 1,048,000.00)** shall be used to finance the cost of this procurement.

- 2.2. Payments will be made by NPC upon approval of the claims in accordance with the provisions, terms and conditions of the contract and existing and applicable law.

### 3. Corrupt, Fraudulent, Collusive, and Coercive Practices

- 3.1. NPC as well as the bidders and suppliers shall observe the highest standard of ethics during the procurement and execution of the contract. In pursuance of this policy, NPC:

- (a) defines, for purposes of this provision, the terms set forth below as follows:
- (i) “corrupt practice” means behavior on the part of officials in the public or private sectors by which they improperly and unlawfully enrich themselves, others, or induce others to do so, by misusing the position in which they are placed, and includes the offering, giving, receiving, or soliciting of anything of value to influence the action of any such official in the procurement process or in contract execution; entering, on behalf of the government, into any contract or transaction manifestly and grossly disadvantageous to the same, whether or not the public officer profited or will profit thereby, and similar acts as provided in RA 3019.
  - (ii) “fraudulent practice” means a misrepresentation of facts in order to influence a procurement process or the execution of a contract to the detriment of NPC, and includes collusive practices among Bidders (prior to or after bid submission) designed to establish bid prices at artificial, non-competitive levels and to deprive NPC of the benefits of free and open competition.
  - (iii) “collusive practices” means a scheme or arrangement between two or more Bidders, with or without the knowledge of NPC, designed to establish bid prices at artificial, non-competitive levels.
  - (iv) “coercive practices” means harming or threatening to harm, directly or indirectly, persons, or their property to influence their participation in a procurement process, or affect the execution of a contract;
  - (v) “obstructive practice” is
    - (aa) deliberately destroying, falsifying, altering or concealing of evidence material to an administrative proceedings or investigation or making false statements to investigators in order to materially impede an administrative proceedings or investigation of NPC or any foreign government/foreign or international financing institution into allegations of a corrupt, fraudulent, coercive or collusive practice; and/or

threatening, harassing or intimidating any party to prevent it from disclosing its knowledge of matters relevant to the administrative proceedings or investigation or from pursuing such proceedings or investigation; or

- (bb) acts intended to materially impede the exercise of the inspection and audit rights of NPC or any foreign government/foreign or international financing institution herein.
  - (b) will reject a proposal for award if it determines that the Bidder recommended for award has engaged in any of the practices mentioned in this Clause for purposes of competing for the contract.
- 3.2. Further, NPC will seek to impose the maximum civil, administrative, and/or criminal penalties available under applicable laws on individuals and organizations deemed to be involved in any of the practices mentioned in ITB Clause 3.1(a).
- 3.3. Furthermore, NPC reserve the right to inspect and audit records and accounts of a bidder or supplier in the bidding for and performance of a contract themselves or through independent auditors as reflected in the **GCC** Clause 3.

#### 4. Conflict of Interest

- 4.1. All Bidders found to have conflicting interests shall be disqualified to participate in the procurement at hand, without prejudice to the imposition of appropriate administrative, civil, and criminal sanctions. A Bidder may be considered to have conflicting interests with another Bidder in any of the events described in paragraphs (a) through (c) below and a general conflict of interest in any of the circumstances set out in paragraphs (d) through (g) below:
- (a) A Bidder has controlling shareholders in common with another Bidder;
  - (b) A Bidder receives or has received any direct or indirect subsidy from any other Bidder;
  - (c) A Bidder has the same legal representative as that of another Bidder for purposes of this bid;
  - (d) A Bidder has a relationship, directly or through third parties, that puts them in a position to have access to information about or influence on the bid of another Bidder or influence the decisions of NPC regarding this bidding process;
  - (e) A Bidder submits more than one bid in this bidding process. However, this does not limit the participation of subcontractors in more than one bid;



- (f) A Bidder who participated as a consultant in the preparation of the design or technical specifications of the Goods and related services that are the subject of the bid; or
  - (g) A Bidder who lends, or temporarily seconds, its personnel to firms or organizations which are engaged in consulting services for the preparation related to procurement for or implementation of the project, if the personnel would be involved in any capacity on the same project.
- 4.2. In accordance with Section 47 of the IRR of RA 9184, all Bidding Documents shall be accompanied by a sworn affidavit of the Bidder that it is not related to the Head of Procuring Entity/NPC (HoPE), members of the Bids and Awards Committee (BAC), members of the Technical Working Group (TWG), members of the BAC Secretariat, the head of the Project Management Office (PMO) or the end-user unit, and the project consultants, by consanguinity or affinity up to the third civil degree. On the part of the Bidder, this Clause shall apply to the following persons:
- (a) If the Bidder is an individual or a sole proprietorship, to the Bidder himself;
  - (b) If the Bidder is a partnership, to all its officers and members;
  - (c) If the Bidder is a corporation, to all its officers, directors, and controlling stockholders;
  - (d) If the Bidder is a cooperative, to all its officers, directors, and controlling shareholders or members; and
  - (e) If the Bidder is a joint venture (JV), the provisions of items (a), (b), (c), or (d) of this Clause shall correspondingly apply to each of the members of the said JV, as may be appropriate.

Relationship of the nature described above or failure to comply with this Clause will result in the automatic disqualification of a Bidder.

## 5. Eligible Bidders

- 5.1. The following persons shall be eligible to participate in this bidding:
- (a) Duly licensed Filipino citizens/sole proprietorships;
  - (b) Partnerships duly organized under the laws of the Philippines and of which at least sixty percent (60%) of the interest belongs to citizens of the Philippines;
  - (c) Corporations duly organized under the laws of the Philippines, and of which at least sixty percent (60%) of the outstanding capital stock belongs to citizens of the Philippines;
  - (d) Cooperatives duly organized under the laws of the Philippines; and
  - (e) Persons/entities forming themselves into a Joint Venture (JV), *i.e.*, a group of two (2) or more persons/entities that intend to be jointly and severally responsible or liable for a particular contract: Provided,

however, that Filipino ownership or interest of the JV concerned shall be at least sixty percent (60%).

- 5.2. Foreign bidders may be eligible to participate when any of the following circumstances exist:
- (a) When a Treaty or International or Executive Agreement as provided in Section 4 of RA 9184 and its IRR allow foreign bidders to participate;
  - (b) Citizens, corporations, or associations of a country, the laws or regulations of which grant reciprocal rights or privileges to citizens, corporations, or associations of the Philippines;
  - (c) When the Goods sought to be procured are not available from local suppliers; or
  - (d) When there is a need to prevent situations that defeat competition or restrain trade.
- 5.3. Government owned or – controlled corporations (GOCCs) may be eligible to participate only if they can establish that they (a) are legally and financially autonomous, (b) operate under commercial law, and (c) are not attached agencies of NPC.
- 5.4. The Bidder must have completed a Single Largest Completed Contract (SLCC) similar to the Project and the value of which, adjusted, if necessary, by the Bidder to current prices using the Philippine Statistics Authority (PSA) consumer price index, must be at least equivalent to Fifty Percent (50%) of the ABC.

For this purpose, similar contracts shall refer to similar contracts refer to Supply and Delivery or Restoration of Strong Motion Accelerometers/Standpipe Piezometer/Dam Instrumentations.

The Single Largest Completed Contract (SLCC) as declared by the bidder shall be verified and validated to ascertain such completed contract. Hence, bidders must ensure access to sites of such projects/equipment to NPC representatives for verification and validation purposes during post-qualification process.

It shall be a ground for disqualification, if verification and validation cannot be conducted for reasons attributable to the Bidder.

- 5.5. The Bidder must submit a computation of its Net Financial Contracting Capacity (NFCC), which must be at least equal to the ABC to be bid, calculated as follows:

$$\text{NFCC} = [(\text{Current assets minus current liabilities}) (15)] \text{ minus the value of all outstanding or uncompleted portions of the projects under ongoing contracts, including awarded contracts yet to be started, coinciding with the contract to be bid.}$$

The values of the domestic bidder's current assets and current liabilities be based on the latest Audited Financial Statements submitted to the

For purposes of computing the foreign bidders' NFCC, the current assets and current liabilities shall be based on their aud

statements prepared in accordance with international financial reporting standards.

If the prospective bidder opts to submit a Committed Line of Credit (CLC), it must be at least equal to ten percent (10%) of the ABC to be bid. If issued by a foreign universal or commercial bank, it shall be confirmed or authenticated by a local universal or commercial bank.

Further, if the Bidder opted to submit a Committed Line of Credit (CLC), the bidder must submit a granted credit line valid/effective at the date of bidding.

## 6. Bidder's Responsibilities

- 6.1. The Bidder or its duly authorized representative shall submit an Omnibus sworn statement in the form prescribed in **Section V – Bidding Forms** as required in **ITB** Clause 12.1(b)(ii).
- 6.2. The Bidder is responsible for the following:
  - (a) Having taken steps to carefully examine all of the Bidding Documents;
  - (b) Having acknowledged all conditions, local or otherwise, affecting the implementation of the contract;
  - (c) Having made an estimate of the facilities available and needed for the contract to be bid, if any;
  - (d) Having complied with its responsibility to inquire or secure Supplemental/Bid Bulletin(s) as provided under **ITB** Clause 10.3.
  - (e) Ensuring that it is not "blacklisted" or barred from bidding by the GOP or any of its agencies, offices, corporations, or LGUs, including foreign government/foreign or international financing institution whose blacklisting rules have been recognized by the GPPB;
  - (f) Ensuring that each of the documents submitted in satisfaction of the bidding requirements is an authentic copy of the original, complete, and all statements and information provided therein are true and correct;
  - (g) Authorizing the HoPE or its duly authorized representative/s to verify all the documents submitted;
  - (h) Ensuring that the signatory is the duly authorized representative of the Bidder, and granted full power and authority to do, execute and perform any and all acts necessary and/or to represent the Bidder in the bidding, with the duly notarized Secretary's Certificate attesting to such fact, if the Bidder is a corporation, partnership, cooperative, or joint venture;
  - (i) Complying with the disclosure provision under Section 47 of RA 9184 and its IRR in relation to other provisions of RA 3019;

- (j) Complying with existing labor laws and standards, in the case of procurement of services; Moreover, bidder undertakes to:
- (i) Ensure the entitlement of workers to wages, hours of work, safety and health and other prevailing conditions of work as established by national laws, rules and regulations; or collective bargaining agreement; or arbitration award, if and when applicable.
- In case there is a finding by NPC or the DOLE of underpayment or non-payment of workers' wage and wage-related benefits, bidder agrees that the performance security or portion of the contract amount shall be withheld in favor of the complaining workers pursuant to appropriate provisions of Republic Act No. 9184 without prejudice to the institution of appropriate actions under the Labor Code, as amended, and other social legislations.
- (ii) Comply with occupational safety and health standards and to correct deficiencies, if any.
- In case of imminent danger, injury or death of the worker, bidder undertakes to suspend contract implementation pending clearance to proceed from the DOLE Regional Office and to comply with Work Stoppage Order; and
- (iii) Inform the workers of their conditions of work, labor clauses under the contract specifying wages, hours of work and other benefits under prevailing national laws, rules and regulations; or collective bargaining agreement; or arbitration award, if and when applicable, through posting in two (2) conspicuous places in the establishment's premises; and
- (k) Ensuring that it did not give or pay, directly or indirectly, any commission, amount, fee, or any form of consideration, pecuniary or otherwise, to any person or official, personnel or representative of the government in relation to any procurement project or activity.

Failure to observe any of the above responsibilities shall be at the risk of the Bidder concerned.

- 6.3. The Bidder is expected to examine all instructions, forms, terms, and specifications in the Bidding Documents.
- 6.4. It shall be the sole responsibility of the Bidder to determine and to satisfy itself by such means as it considers necessary or desirable as to all matters pertaining to the contract to be bid, including: (a) the location and the nature of this Project; (b) climatic conditions; (c) transportation facilities; and (d) other factors that may affect the cost, duration, and execution or implementation of this Project.
- 6.5. NPC shall not assume any responsibility regarding erroneous interpretations or conclusions by the prospective or eligible bidder out of the data furnished

by NPC. However, NPC shall ensure that all information in the Bidding Documents, including bid/supplemental bid bulletin/s issued, are correct and consistent.

- 6.6. Before submitting their bids, the Bidder is deemed to have become familiar with all existing laws, decrees, ordinances, acts and regulations of the Philippines which may affect this Project in any way.
- 6.7. The Bidder shall bear all costs associated with the preparation and submission of his bid, and NPC will in no case be responsible or liable for those costs, regardless of the conduct or outcome of the bidding process.
- 6.8. The Bidder should note that NPC will accept bids only from those that have paid the applicable fee for the Bidding Documents at the office indicated in the Invitation to Bid.

## 7. Origin of Goods

There is no restriction on the origin of goods other than those prohibited by a decision of the United Nations Security Council taken under Chapter VII of the Charter of the United Nations, subject to ITB Clause 24.1.

## 8. Subcontracts

Subcontracting may be allowed on transport, local/non-skilled labor under the supervision of the Bidder. The Bidder shall not be relieved from any liability or obligation that may arise from the performance of the Subcontractor. The Bidder shall also submit the complete eligibility documents of proposed sub-contractor, if any.

## 9. Negotiation

- 9.1. Negotiation shall be held at the venue and on the date indicated in the invitation, to clarify concerns on the technical and financial components of this procurement.
- 9.2. Bidders are encouraged to attend the negotiation to ensure that they fully understand NPC's requirements. Non-attendance of the Bidder will in no way prejudice its bid; however, the Bidder is expected to know the changes and/or amendments to the TOR discussed during the negotiation.
- 9.3. Any statement made at the negotiation shall not modify the Terms of Reference unless such statement is specifically identified in writing as an amendment thereto and issued as a Supplemental/Bid Bulletin.
- 9.4. Following completion of the negotiations, NPC shall request all Bidders remaining in the proceedings to submit, on a specified date, a best and final offer with respect to all aspects of their bid proposals.

## 10. Clarification and Amendment of TOR

- 10.1. Bidders may request for clarifications on any part of the documents for an interpretation during the negotiation meeting.

- 10.2. Supplemental/Bid Bulletins may be issued upon NPC's initiative for purposes of clarifying or modifying any provision of the Bidding Documents not later than seven (7) calendar days before the deadline for the submission and receipt of bids. Any modification to the Bidding Documents shall be identified as an amendment.
- 10.3. Any Supplemental/Bid Bulletin issued by the BAC shall also be posted on the Philippine Government Electronic Procurement System (PhilGEPS) and the website of NPC, if available. It shall be the responsibility of all Bidders who secure the Bidding Documents to inquire and secure Supplemental/Bid Bulletins that may be issued by the BAC.

## B. Preparation of Bids

### 11. Language of Bids

- 11.1. The eligibility requirements or statements, the bids, and all other documents to be submitted to the BAC must be in English. If the eligibility requirements or statements, the bids, and all other documents submitted to the BAC are in foreign language other than English, it must be accompanied by a translation of the documents in English. The documents shall be translated by the relevant foreign government agency, the foreign government agency authorized to translate documents, or a registered translator in the foreign bidder's country; and shall be authenticated by the appropriate Philippine foreign service establishment/post or the equivalent office having jurisdiction over the foreign bidder's affairs in the Philippines. The English translation shall govern, for purposes of interpretation of the bid.

### 12. Documents Comprising the Bid: Eligibility and Technical Components

- 12.1. The first envelope shall contain the following eligibility and technical documents:

- (a) Eligibility Documents –

Class "A" Documents:

- (i) The prospective bidder shall submit a valid and updated Certificate of PhilGEPs Registration under Platinum Membership (all pages including the Annex A of the said Certificate). **Non-compliance shall be a ground for disqualification.**
- (ii) Statement of all its ongoing government and private contracts, including contracts awarded but not yet started, if any, whether similar or not similar in nature and complexity to the contract to be bid; and

Statement of the Bidder's SLCC similar to the contract to be bid, in accordance with ITB Clause 5.4.

The two statements required shall indicate for each contract the following:

- (ii.1) name of the contract;
- (ii.2) date of the contract;
- (ii.3) contract duration;
- (ii.4) owner's name and address;
- (ii.5) kinds of Goods;
- (ii.6) For Statement of Ongoing Contracts - amount of contract and value of outstanding contracts;
- (ii.7) For Statement of SLCC - amount of completed contracts, adjusted by the Bidder to current prices using PSA's consumer price index, if necessary for the purpose of meeting the SLCC requirement;
- (ii.8) date of delivery; and
- (ii.9) end user's acceptance or official receipt(s) or sales invoice issued for the contract, if completed, which shall be attached to the statements.

The Statement of the bidder's Single Largest Completed Contract (SLCC) similar to the contract to be bid (Form No. NPCSF-GOODS-03) shall be supported by the following documents to be submitted during Bid Opening:

1. Certificate of Acceptance; or Certificate of Completion; or Official Receipt (O.R); or Sales Invoice

The list of on-going contracts (Form No. NPCSF-GOODS-02) shall be supported by the following documents for each on-going contract to be submitted during Post-Qualification:

1. Contract/Purchase Order and/or Notice of Award

The bidder shall declare in this form all his on-going government and private contracts including contracts where the bidder (either as individual or as a Joint Venture) is a partner in a Joint Venture agreement other than his current joint venture where he is a partner. Non declaration will be a ground for disqualification of bid.

- (iii) NFCC computation in accordance with ITB Clause 5.5 or a committed Line of Credit from a universal or commercial bank.

Class "B" Document:

- (iv) If applicable, the Joint Venture Agreement (JVA) in case the joint venture is already in existence, or duly notarized statements from all the potential joint venture partners in accordance with Section 23.1(b) of the revised IRR of R.A. 9184.

Each partner of the joint venture shall submit their respective PhilGEPS Certificates of Registration in accordance with Section 8.5.2 of the IRR of RA 9184. The submission of technical and financial eligibility documents by any of the joint venture partners constitutes compliance: *Provided*, That the partner responsible to submit the NFCC shall likewise submit the Statement of all of its ongoing contracts and Audited Financial Statements.

Any single bidder/s who already procured/secured the bidding documents but want to avail the Joint Venture Agreement (JVA) shall inform the BAC in writing prior to the bid opening for records and documentation purposes.

(b) Technical Documents –

- (i) Drawings and documents to be submitted with the Bid/Proposal as specified in Clause TS-11.0(a) of Section III - Technical Specifications.
- (ii) Omnibus Sworn statement in accordance with Section 25.2(a) (vii) of the IRR of RA 9184 and using the form prescribed in Section V – Bidding Forms.
- (iii) Complete eligibility documents of the proposed sub-contractor, if any

- 12.2. In the case of foreign bidders, except for the Tax Clearance, the eligibility requirements under Class "A" Documents may be substituted by the appropriate equivalent documents, if any, issued by the country of the foreign bidder concerned. The eligibility requirements or statements, the bids, and all other documents to be submitted to the BAC must be in English. If the eligibility requirements or statements, the bids, and all other documents submitted to the BAC are in foreign language other than English, it must be accompanied by a translation of the documents in English. The documents shall be translated by the relevant foreign government agency, the foreign government agency authorized to translate documents, or a registered translator in the foreign bidder's country; and shall be authenticated by the appropriate Philippine foreign service establishment/post or the equivalent office having jurisdiction over the foreign bidder's affairs in the Philippines.

These documents shall be accompanied by a Sworn Statement in a form prescribed by the GPPB stating that the documents submitted are complete and authentic copies of the original, and all statements and information provided therein are true and correct. Upon receipt of the said documents, the PhilGEPS shall process the same in accordance with the guidelines on the Government of the Philippines – Official Merchants Registry (GoP-OMR).



**13. Documents Comprising the Bid: Financial Component**

- 13.1. The financial component of the bid shall contain the following:
- (a) Duly signed Bid Letter indicating the total bid amount in accordance with the form prescribed in Section V – Bidding Forms;
  - (b) Duly signed and completely filled-out Bid Price Schedule/Schedule of Requirements (Section IV) indicating the unit and total prices per item and the total amount in the prescribed Price Schedule form.
- 13.2. Price proposals that exceed the ABC shall be rejected.
- 13.3. In case a bidder will not submit bid for reason that his cost estimate is higher than the ABC, said bidder is required to submit his letter of non-participation/regret supported by corresponding detailed estimates. Failure to submit the two (2) documents shall be understood as acts that tend to defeat the purpose of public bidding without valid reason as stated under Section 69.1.(i) of the revised IRR of R.A. 9184.

**14. Alternative Bids**

- 14.1 Alternative Bids shall be rejected. For this purpose, alternative bid is an offer made by a Bidder in addition or as a substitute to its original bid which may be included as part of its original bid or submitted separately therewith for purposes of bidding. A bid with options is considered an alternative bid regardless of whether said bid proposal is contained in a single envelope or submitted in two (2) or more separate bid envelopes.
- 14.2 Each Bidder shall submit only one Bid, either individually or as a partner in a JV. A Bidder who submits or participates in more than one bid (other than as a subcontractor if a subcontractor is permitted to participate in more than one bid) will cause all the proposals with the Bidder's participation to be disqualified. This shall be without prejudice to any applicable criminal, civil and administrative penalties that may be imposed upon the persons and entities concerned.

**15. Bid Prices**

- 15.1. The Bidder shall complete the appropriate Schedule of Prices included herein, stating the unit prices, total price per item, the total amount and the expected countries of origin of the Goods to be supplied under this Project.
- 15.2. Bidders shall fill-out Section IV (Schedule of Requirements/Bid Price Schedule) in the following manner:

For items sourced from abroad, the Bidder shall only fill up the required data under the columns E (**currency shall be in US Dollar**), F, G and H for the **“Unit Price of Goods and Services to be Supplied from Abroad”** and indicate zero (0) or dash (-) under the columns I, J & K for the **“Unit Price of Goods and Related Services to be Supplied from Within the Philippines”**.

In the same manner, for items sourced locally, the Bidder shall only fill up the required data under the columns I, J & K for the **“Unit Price of Goods and Related Services to be Supplied from Within the Philippines”** and indicate zero (0) or dash (-) under the columns E, F, G and H for the **“Unit Price of Goods and Services to be Supplied from Abroad”**.

Filling up of prices for both goods and services (abroad and local portion) for the same pay item shall not allowed and will be disqualified.

The total price for the foreign sourced or the locally sourced item (whichever is the case) multiplied by the quantity shall then be indicated in column L or M respectively. For foreign sourced items with Peso portions, both the foreign portion (Column L) and Peso portion (Column M) shall be indicated in the total price.

It is further reiterated, that where a required item is provided, but no price is indicated, the same shall be considered as non-responsive, but specifying a zero (0) or dash (-) for the said item would mean that it is being offered for free to the Government, except those required by law or regulations to be provided for.

- 15.3. The terms Ex Works (EXW), Cost, Insurance and Freight (CIF), Cost and Insurance Paid to (CIP), Delivered Duty Paid (DDP), and other trade terms used to describe the obligations of the parties, shall be governed by the rules prescribed in the current edition of the International Commercial Terms (INCOTERMS) published by the International Chamber of Commerce, Paris.
- 15.4. Prices indicated on the Price Schedule shall be entered separately in the following manner:
- (a) For Goods offered from within the Philippines:
    - (i) The price of the Goods quoted EXW (ex works, ex factory, ex warehouse, ex showroom, or off-the-shelf, as applicable);
    - (ii) The cost of all customs duties and sales and other taxes already paid or payable;
    - (iii) The cost of transportation, insurance, and other costs incidental to delivery of the Goods to their final destination; and
    - (iv) The price of other (incidental) services, specified in Clause 6.2 of the **GCC** and the Technical Specifications.
  - (b) For Goods offered from abroad:
    - (i) The price of the Goods shall be quoted DDP with the place of destination in the Philippines as specified in the Technical Specifications. In quoting the price, the Bidder shall be free to use transportation through carriers registered in any eligible country. Similarly, the Bidder may obtain insurance services from any eligible source country.

- (ii) The price of other (incidental) services, if any.
  - (c) For Services, based on the form which may be prescribed by NPC, in accordance with existing laws, rules and regulations
- 15.5. Prices quoted by the Bidder shall be fixed during the Bidder's performance of the contract and not subject to variation or price escalation on any account. A bid submitted with an adjustable price quotation shall be treated as non-responsive and shall be rejected, pursuant to **ITB Clause 21**.

All bid prices for the given scope of work in the contract as awarded shall be considered as fixed prices, and therefore not subject to price escalation during contract implementation, except under extraordinary circumstances. Upon the recommendation of NPC, price escalation may be allowed in extraordinary circumstances as may be determined by the National Economic and Development Authority in accordance with the Civil Code of the Philippines, and upon approval by the GPPB. Nevertheless, in cases where the cost of the awarded contract is affected by any applicable new laws, ordinances, regulations, or other acts of the GOP, promulgated after the date of bid opening, a contract price adjustment shall be made or appropriate relief shall be applied on a no loss-no gain basis.

## 16. Bid Currencies

- 16.1. Prices shall be quoted in the following currencies:
- (a) For Goods that the Bidder will supply from within the Philippines, the prices shall be quoted in Philippine Pesos.
  - (b) For Goods that the Bidder will supply from outside the Philippines, the prices may be quoted in the currency(ies) acceptable to NPC. However, for purposes of bid evaluation, bids denominated in foreign currencies shall be converted to Philippine currency based on the exchange rate as published in the *Bangko Sentral ng Pilipinas (BSP)* reference rate bulletin on the day of the bid opening.
- 16.2. If so allowed in accordance with **ITB Clause 16.1**, NPC for purposes of bid evaluation and comparing the bid prices will convert the amounts in various currencies in which the bid price is expressed to Philippine Pesos at the foregoing exchange rates.
- 16.3. Payment of the contract price shall be made in Philippine Pesos.

## 17. Bid Validity

- 17.1. Bids shall remain valid for the period of **ONE HUNDRED TWENTY (120) CALENDAR DAYS** from the date of the opening of bids.
- 17.2. In exceptional circumstances, prior to the expiration of the bid validity period, NPC may request Bidders to extend the period of validity of their bids. The request and the responses shall be made in writing. A Bidder may refuse the request, but his bid shall no longer be considered for further evaluation and

award. A Bidder granting the request shall not be required or permitted to modify its bid.

## 18. Format and Signing of Bids

- 18.1. Bidders shall submit their bids through their duly authorized representative using the appropriate forms provided in **Section V – Bidding Forms** on or before the deadline specified in the **ITB** Clauses 20 in two (2) separate sealed bid envelopes, and which shall be submitted simultaneously. The first shall contain the technical component of the bid, including the eligibility requirements under **ITB** Clause 12.1, and the second shall contain the financial component of the bid. This shall also be observed for each lot in the case of lot procurement.
- 18.2. Forms as mentioned in **ITB** Clause 18.1 must be completed without any alterations to their format, and no substitute form shall be accepted. All blank spaces shall be filled in with the information requested.
- 18.3. Each and every page of the Bid Letter, including the **Schedule of Requirements (Bid Price Schedule)**, under Section IV hereof, shall be signed by the duly authorized representative/s of the Bidder. Failure to do so shall be a ground for the rejection of the bid.
- 18.4. Any interlineations, erasures, or overwriting shall be valid only if they are signed or initialed by the duly authorized representative/s of the Bidder.

## 19. Sealing and Marking of Bids

Each Bidder shall submit Two (2) copies of the first and second components of its Bid, marked **Original** and photocopy. Only the original copy will be read and considered for the bid.

Any misplaced document outside of the **Original** copy will not be considered. The photocopy is ONLY FOR REFERENCE.

The Procuring Entity may request additional hard copies and/or electronic copies of the Bid. However, failure of the Bidders to comply with the said request shall not be a ground for disqualification.

If the Procuring Entity allows the submission of bids through online submission to the given website or any other electronic means, the Bidder shall submit an electronic copy of its Bid, which must be digitally signed. An electronic copy that cannot be opened or is corrupted shall be considered non-responsive and, thus, automatically disqualified.

Bidders must also comply with the Disclaimer and Data Privacy Notice specified below:

All bid submissions and related correspondences are confidential and for viewing only by the intended recipient/s. Any unauthorized access to review, reproduce, or disseminate the information contained therein is strictly prohibited. The National Power Corporation (NAPOCOR) does not guarantee the security of any information electronically transmitted.

Bid submissions and related correspondences may contain personal and sensitive personal information, and are subject to the Data Privacy Act of 2012, its implementing rules, regulations and issuances of the National Privacy Commission of the Philippines (“Privacy Laws”). By viewing, using, storing, sharing and disposing (collectively “Processing”), such bids submissions and correspondences, you agree to comply with the Privacy Laws. By responding to correspondence, you consent to the Processing by NAPOCOR of the Personal Data contained in your submission/reply in accordance with NAPOCOR’s Personal Data Privacy Policy which you can find at <http://www.napocor.gov.ph>.

To report any privacy issue, contact the Data Privacy Officer at [dpo@napocor.gov.ph](mailto:dpo@napocor.gov.ph).

NAPOCOR is not liable for the proper and complete transmission of the information contained in bid submission/correspondences nor for any delay in its receipt.

### **C. Submission and Opening of Bids**

#### **20. Deadline for Submission of Bids**

- 20.1. Proposals must be received by the BAC on the date and time agreed upon during negotiation meeting.
- 20.2. Any bid submitted after the deadline for submission and receipt of bids prescribed by NPC, pursuant to ITB Clause 20, shall be declared “Late” and shall not be accepted by NPC. The BAC shall record in the minutes of bid submission and opening, the Bidder’s name, its representative and the time the late bid was submitted.
- 20.3. In case the bids cannot be opened as scheduled due to justifiable reasons, the BAC shall take custody of the bids submitted and reschedule the opening of bids on the next working day or at the soonest possible time through the issuance of a Notice of Postponement to be posted in the PhilGEPS website and the website of NPC.

#### **21. Opening and Preliminary Examination of Bids**

- 21.1. The BAC shall open the bids in public, immediately after the deadline for the submission and receipt of bids. In case the Bids cannot be opened as scheduled due to justifiable reasons, the BAC shall take custody of the Bids submitted and reschedule the opening of Bids on the next working day or at the soonest possible time through the issuance of a Notice of Postponement to be posted in the PhilGEPS website and the website of NPC.
- 21.2. The BAC shall open the first bid envelopes and determine each Bidder’s compliance with the documents prescribed in ITB Clause 12, using a non-discretionary “pass/fail” criterion. If a Bidder submits the required document, it shall be rated “passed” for that particular requirement. In this regard, bids that fail to include any requirement or are incomplete or patently insufficient shall be considered as “failed”. Otherwise, the BAC shall rate the said first bid envelope as “passed”.

- 21.3. Immediately after determining compliance with the requirements in the first envelope, the BAC shall forthwith open the second bid envelope of each remaining eligible bidder whose first bid envelope was rated "passed". The second envelope of each complying bidder shall be opened within the same day. In case one or more of the requirements in the second envelope of a particular bid is missing, incomplete or patently insufficient, and/or if the submitted total bid price exceeds the ABC unless otherwise provided in **ITB** Clause 13.1(b), the BAC shall rate the bid concerned as "failed". Only bids that are determined to contain all the bid requirements for both components shall be rated "passed" and shall immediately be considered for evaluation and comparison.
- 21.4. Letters of non-participation/regret shall be read out and recorded during bid opening.
- 21.5. All members of the BAC who are present during bid opening shall initial every page of the original copies of all bids received and opened.
- 21.6. In the case of an eligible foreign bidder as described in **ITB** Clause 5, the following Class "A" Documents may be substituted with the appropriate equivalent documents, if any, issued by the country of the foreign Bidder concerned, which shall likewise be uploaded and maintained in the PhilGEPS in accordance with Section 8.5.2 of the IRR:
- (a) Registration certificate from the Securities and Exchange Commission (SEC), Department of Trade and Industry (DTI) for sole proprietorship, or CDA for cooperatives;
  - (b) Mayor's/Business permit issued by the local government where the principal place of business of the bidder is located; and
  - (c) Audited Financial Statements showing, among others, the prospective bidder's total and current assets and liabilities stamped "received" by the Bureau of Internal Revenue or its duly accredited and authorized institutions, for the preceding calendar year which should not be earlier than two years from the date of bid submission.
- 21.7. Each partner of a joint venture agreement shall likewise submit the requirements in **ITB** Clause 12.1(a)(i). Submission of other documents required under **ITB** Clauses 12.1 by any of the joint venture partners constitutes compliance.
- 21.8. NPC shall prepare the minutes of the proceedings of the bid opening that shall include, as a minimum: (a) names of Bidders, their bid price (per lot, if applicable, and/or including discount, (if any), findings of preliminary examination, and whether there is a withdrawal or modification; and (b) attendance sheet. The BAC members shall sign the abstract of bids as read.
- 24.8 The bidders or their duly authorized representatives may attend the opening of bids. The BAC shall ensure the integrity, security, and confidentiality of all submitted bids. The Abstract of Bids as read and the minutes of the bid opening shall be made available to the public upon written request and payment of a specified fee to recover cost of materials.

- 24.9 To ensure transparency and accurate representation of the bid submission, the BAC Secretariat shall notify in writing all bidders whose bids it has received through its PhilGEPS-registered physical address or official e-mail address. The notice shall be issued within seven (7) calendar days from the date of the bid opening.

#### **D. Evaluation and Comparison of Bids**

##### **22. Process to be Confidential**

- 22.1. Members of the BAC, including its staff and personnel, as well as its Secretariat and TWG, are prohibited from making or accepting any kind of communication with any bidder regarding the evaluation of their bids until the issuance of the Notice of Award, unless otherwise allowed in the case of **ITB** Clause 26.
- 22.2. Any effort by a bidder to influence NPC in its decision in respect of bid evaluation, bid comparison or contract award will result in the rejection of the Bidder's bid.

##### **23. Clarification of Bids**

To assist in the evaluation, comparison, and post-qualification of the bids, NPC may ask in writing any Bidder for a clarification of its bid. All responses to requests for clarification shall be in writing. Any clarification submitted by a Bidder in respect to its bid and that is not in response to a request by NPC shall not be considered.

##### **24. Domestic Preference**

- 24.1. NPC will grant a margin of preference for the purpose of comparison of bids in accordance with the following:
- (a) The preference shall be applied when the lowest Foreign Bid is lower than the lowest bid offered by a Domestic Bidder.
  - (b) For evaluation purposes, the lowest Foreign Bid shall be increased by fifteen percent (15%).
  - (c) In the event that the lowest bid offered by a Domestic Bidder does not exceed the lowest Foreign Bid as increased, then NPC shall award the contract to the Domestic Bidder at the amount of the lowest Foreign Bid.
- 24.2. If the Domestic Bidder refuses to accept the award of contract at the amount of the Foreign Bid within two (2) calendar days from receipt of written advice from the BAC, NPC shall award to the bidder offering the Foreign Bid, subject to post-qualification and submission of all the documentary requirements under these Bidding Documents.
- 24.3. A Bidder may be granted preference as a Domestic Bidder subject to the certification from the DTI that the Bidder is offering unmanufactured articles, materials or supplies of the growth or production of the Philippines, or manufactured articles, materials, or supplies manufactured or to be

manufactured in the Philippines substantially from articles, materials, or supplies of the growth, production, or manufacture, as the case may be, of the Philippines.

## 25. Detailed Evaluation and Comparison of Bids

25.1. NPC will undertake the detailed evaluation and comparison of bids which have passed the opening and preliminary examination of bids, pursuant to ITB Clause 21, in order to determine the Lowest Calculated Bid.

25.2. The Lowest Calculated Bid shall be determined in two steps:

- (a) The detailed evaluation of the financial component of the bids, to establish the correct calculated prices of the bids; and
- (b) The ranking of the total bid prices as so calculated from the lowest to the highest. The bid with the lowest price shall be identified as the Lowest Calculated Bid.

25.3. NPC's BAC shall immediately conduct a detailed evaluation of all bids rated "passed," using non-discretionary pass/fail criteria. The BAC shall consider the following in the evaluation of bids:

- (a) Completeness of the bid. Bids not addressing or providing all of the required items in the Schedule of Requirements including, where applicable, Schedule of Prices, shall be considered non-responsive and, thus, automatically disqualified. In this regard, where a required item is provided, but no price is indicated, the same shall be considered as non-responsive, but specifying a zero (0) or a dash (-) for the said item would mean that it is being offered for free to NPC, except those required by law or regulations to be provided for; and
- (b) Arithmetical corrections. Consider computational errors and omissions to enable proper comparison of all eligible bids. It may also consider bid modifications. Any adjustment shall be calculated in monetary terms to determine the calculated prices. In case of discrepancies between:
  1. bid prices in figures and in words, the latter shall prevail;
  2. total price per item and unit price for the item as extended or multiplied by the quantity of that item, the latter shall prevail;
  3. the total Bid amount and the sum of total costs per item, the sum of the total costs per item shall prevail and the total Bid amount will be corrected;
  4. unit cost in the detailed estimate and unit cost in the Bid Price Schedule, the latter shall prevail;
- (c) The goods are grouped in a single lot and the lot shall not be divided into sub-lots for the purpose of bidding, evaluation, and contract award. The Bidders bid offer for each item must be within the ABC.



Bidders with bid offers that exceed the ABC or with incomplete price shall be rejected.

- 25.4. Based on the detailed evaluation of bids, those that comply with the above-mentioned requirements shall be ranked in the ascending order of their total calculated bid prices, as evaluated and corrected for computational errors, discounts and other modifications, to identify the Lowest Calculated Bid. Total calculated bid prices, as evaluated and corrected for computational errors, discounts and other modifications, which exceed the ABC shall not be considered.
- 25.5. NPC's evaluation of bids shall be based on the bid price quoted in the Bid Letter, which includes the Schedule of Prices.
- 25.6. Bids shall be evaluated on an equal footing to ensure fair competition. For this purpose, all bidders shall be required to include in their bids the cost of all taxes, such as, but not limited to, value added tax (VAT), income tax, local taxes, and other fiscal levies and duties which shall be itemized in the bid form and reflected in the detailed estimates. Such bids, including said taxes, shall be the basis for bid evaluation and comparison.
- 25.7. If so indicated pursuant to ITB Clause 1.2, Bids are being invited for individual lots or for any combination thereof, provided that all Bids and combinations of Bids shall be received by the same deadline and opened and evaluated simultaneously so as to determine the Bid or combination of Bids offering the lowest calculated cost to NPC. Bid prices quoted shall correspond to all items specified for each lot and to all quantities specified for each item of a lot.

## **26. Post-Qualification**

- 26.1. The BAC shall determine to its satisfaction whether the Bidder that is evaluated as having submitted the Lowest Calculated Bid complies with and is responsive to all the requirements and conditions specified in ITB Clauses 5, 12, and 13.
- 26.2. Within a non-extendible period of five (5) calendar days from receipt by the bidder of the notice from the BAC that it submitted the Lowest Calculated Bid, the Bidder shall submit the following documents and other appropriate licenses and permits required by law:
  - a. Class A – Eligibility Documents listed on the Annex A of Certificate of PhilGEPs Registration under Platinum Membership pursuant to Section 34.3 of the Revised IRR of R.A. 9184;
  - b. Contract/Purchase Order and/or Notice of Award for the contracts stated in the List of all Ongoing Government & Private Contracts Including Contracts Awarded but not yet Started (NPCSF-GOODS-02);
  - c. Contract/Purchase Order for the contract stated in the Statement of the bidder's Single Largest Completed Contract (SLCC) similar to the contract to be bid (Form No. NPCSF-GOODS-03);

- d. Drawings and documents to be submitted during post-qualification process as specified in Clause TS-11.0(b) of Section III – Technical Specifications, Electrical Works, EW)

Manufacturer's brochures, manuals and other supporting documents of equipment, materials, hardware and tools proposed by the bidders must comply with the technical specifications of such equipment, materials, hardware and tools. It shall be a ground for disqualification if the submitted brochures, manuals and other supporting documents are determined not complying with the specifications during technical evaluation and post-qualification process.

Equipment, materials, hardware and tools proposed by the winning bidder to be supplied, which were evaluated to be complying with the technical specifications, shall not be replaced and must be the same items to be delivered/installed/used during the contract implementation. Any proposed changes/replacement of said items may be allowed on meritorious reasons subject to validation and prior approval by NPC.

Failure to submit any of the post-qualification requirements on time, or a finding against the veracity thereof, shall disqualify the bidder for award. Provided in the event that a finding against the veracity of any of the documents submitted is made, it shall cause the forfeiture of the bid security in accordance with Section 69 of the IRR of RA 9184.

- 26.3. The determination shall be based upon an examination of the documentary evidence of the Bidder's qualifications submitted pursuant to ITB Clauses 12 and 13, as well as other information as NPC deems necessary and appropriate, using a non-discretionary "pass/fail" criterion, which shall be completed within a period of twelve (12) calendar days.
- 26.4. The post-qualification shall verify, validate, and ascertain all statements made and documents submitted by the bidder with the Lowest Calculated Bid/Highest Rated Bid, using non-discretionary criteria, as stated in the Bidding documents. These criteria shall consider, but shall not be limited to, the following:
- a. Legal Requirements. To verify, validate, and ascertain licenses, certificates, permits, and agreements submitted by the bidder, and the fact that it is not included in any "blacklist" as provided in Section 25.3 of IRR-A of RA 9184.
  - b. Technical Requirements. To determine compliance of the goods offered with the requirements specified in the Bidding Documents, including, where applicable:
    - i. Verification and/or inspection and testing of the goods/product, after-sales and/or maintenance capabilities, in applicable cases, as well as checking the following:

- a. Delay in the partial delivery of goods amounting to ten percent (10%) of the contract price in its ongoing government and private contracts;
  - b. If any of these contracts shows the bidder's failure to deliver or perform any or all of the goods or services within the period(s) specified in the contract or within any extension thereof granted by NPC pursuant to a request made by the supplier prior to the delay, and such failure amounts to at least ten percent (10%) of the contract price; or
  - c. Unsatisfactory performance of the supplier's obligations as per contract terms and conditions at the time of inspection.
- ii. Verification and validation of the bidder's stated competence and experience, and the competence and experience of the bidder's key personnel to be assigned to the project.
  - iii. Verification of availability and commitment, and/or inspection and testing for the required capacities and operating conditions, of equipment units to be owned/leased/under purchase by the bidder for use in the contract under bidding, as well as checking the performance of the bidder in its ongoing government and private contracts, if any of these ongoing contracts shows:
    - a. Negative slippage of at least fifteen percent (15%) in any one project or a negative slippage of at least ten percent (10%) in each of two (2) or more contracts;
    - b. Failure of the contractor to commence repair works on ongoing contracts within seven (7) calendar days and to complete them within thirty (30) calendar days after receipt of NPC's notice of defects and deficiencies;
    - c. Failure of the contractor to commence repair works on contracts with pending certificates of acceptance within thirty (30) calendar days and complete them within ninety (90) days after receipt of NPC's notice of defects and failures; or
    - d. Substandard quality of work as per contract plans and specifications, or unsatisfactory performance of the contractor's obligations as per contract terms and conditions, at the time of inspection.

If the BAC verifies any of these deficiencies to be due to the bidder's fault or negligence, the BAC shall disqualify the bidder from the award.

- c. Financial Requirements. To verify, validate and ascertain the bid price proposal of the bidder and, whenever applicable, the required committed Line of Credit in the amount specified and over the period stipulated in the Bidding Documents or the bidder's NFCC to ensure that the bidder can sustain the operating cash flow of the transaction.

- 26.5. If the BAC determines that the Bidder with the Lowest Calculated Bid passes all the criteria for post-qualification, it shall declare the said bid as the LCRB, and recommend to the HoPE the award of contract to the said Bidder at its submitted price or its calculated bid price, whichever is lower.
- 26.6. A negative determination shall result in rejection of the Bidder's Bid, in which event NPC shall proceed to the next Lowest Calculated Bid with a fresh period to make a similar determination of that Bidder's capabilities to perform satisfactorily. If the second Bidder, however, fails the post qualification, the procedure for post qualification shall be repeated for the Bidder with the next Lowest Calculated Bid, and so on until the LCRB is determined for recommendation for contract award.
- 26.7. Within a period not exceeding fifteen (15) calendar days from the determination by the BAC of the LCRB and the recommendation to award the contract, the HoPE or his duly authorized representative shall approve or disapprove the said recommendation.
- 26.8. In the event of disapproval, which shall be based on valid, reasonable, and justifiable grounds as provided for under Section 41 of the IRR of RA 9184, the HoPE shall notify the BAC and the Bidder in writing of such decision and the grounds for it. When applicable, the BAC shall conduct a post-qualification of the Bidder with the next Lowest Calculated Bid. A request for reconsideration may be filed by the bidder with the HoPE in accordance with Section 37.1.3 of the IRR of RA 9184.

## 27. Reservation Clause

- 27.1. Notwithstanding the eligibility or post-qualification of a Bidder, NPC reserves the right to review its qualifications at any stage of the procurement process if it has reasonable grounds to believe that a misrepresentation has been made by the said Bidder, or that there has been a change in the Bidder's capability to undertake the project from the time it submitted its eligibility requirements. Should such review uncover any misrepresentation made in the eligibility and bidding requirements, statements or documents, or any changes in the situation of the Bidder which will affect its capability to undertake the project so that it fails the preset eligibility or bid evaluation criteria, NPC shall consider the said Bidder as ineligible and shall disqualify it from submitting a bid or from obtaining an award or contract.
- 27.2. Based on the following grounds, NPC reserves the right to reject any and all bids, declare a Failure of Bidding at any time prior to the contract award, or not to award the contract, without thereby incurring any liability, and make no assurance that a contract shall be entered into as a result of the bidding:
- (a) If there is *prima facie* evidence of collusion between appropriate public officers or employees of NPC, or between the BAC and any of the Bidders, or if the collusion is between or among the bidders themselves, or between a Bidder and a third party, including any act which restricts, suppresses or nullifies or tends to restrict, suppress or nullify competition;

- (b) If NPC's BAC is found to have failed in following the prescribed bidding procedures; or
- (c) For any justifiable and reasonable ground where the award of the contract will not redound to the benefit of the GOP as follows:
  - (i) If the physical and economic conditions have significantly changed so as to render the project no longer economically, financially or technically feasible as determined by the HoPE;
  - (ii) If the project is no longer necessary as determined by the HoPE; and
  - (iii) If the source of funds for the project has been withheld or reduced through no fault of NPC.

27.3. In addition, NPC may likewise declare a failure of bidding when:

- (a) No bids are received;
- (b) All prospective Bidders are declared ineligible;
- (c) All bids fail to comply with all the bid requirements or fail post-qualification; or
- (d) The bidder with the LCRB refuses, without justifiable cause to accept the award of contract, and no award is made in accordance with Section 40 of the IRR of RA 9184.

#### **E. Award of Contract**

#### **28. Contract Award**

- 28.1. Subject to **ITB** Clause 26, the HoPE or its duly authorized representative shall award the contract to the Bidder whose bid has been determined to be the LCRB, at its submitted price or its calculated bid price, whichever is lower. Contract amount shall be exclusive of computed Fuel Consumption Cost (FFC).
- 28.2. Prior to the expiration of the period of bid validity, NPC shall notify the successful Bidder in writing that its bid has been accepted, through a Notice of Award duly received by the Bidder or its representative personally or sent by registered mail or electronically, receipt of which must be confirmed in writing within two (2) days by the Bidder with the LCRB and submitted personally or sent by registered mail or electronically to NPC.
- 28.3. Notwithstanding the issuance of the Notice of Award, award of contract shall be subject to the following conditions:
  - (a) Submission of the following documents within ten (10) calendar days from receipt of the Notice of Award:
    - (i) Valid JVA, if applicable; or

- (ii) In the case of procurement by a Philippine Foreign Service Office or Post, the PhilGEPS Registration Number of the winning foreign Bidder;
  - (b) Posting of the performance security in accordance with **ITB** Clause 30;
  - (c) Signing of the contract as provided in **ITB** Clause 29; and
  - (d) Approval by higher authority, if required, as provided in Section 37.3 of the IRR of RA 9184.
- 28.4. At the time of contract award, NPC shall not increase or decrease the quantity of goods originally specified in **Section IV – Schedule of Requirements (Bid Price Schedule)**.

## 29. Signing of the Contract

- 29.1. At the same time as NPC notifies the successful Bidder that its bid has been accepted, NPC shall send the Contract Form to the Bidder, which contract has been provided in the Bidding Documents, incorporating therein all agreements between the parties.
- 29.2. Within ten (10) calendar days from receipt of the Notice of Award, the successful Bidder shall post the required performance security, sign and date the contract and return it to NPC.
- 29.3. NPC shall enter into contract with the successful Bidder within the same ten (10) calendar day period provided that all the documentary requirements are complied with.
- 29.4. The following documents shall form part of the contract:
- (a) Contract Agreement;
  - (b) Bidding Documents;
  - (c) Winning bidder's bid, including the Technical and Financial Proposals, and all other documents/statements submitted (e.g., bidder's response to request for clarifications on the bid), including corrections to the bid, if any, resulting from NPC's bid evaluation;
  - (d) Notice of Award of Contract; and
  - (e) Other contract documents that may be required by existing laws and/or NPC under these Bidding Documents.

## 30. Performance Security

- 30.1. To guarantee the faithful performance by the winning Bidder of its obligations under the contract, it shall post a performance security within a maximum period of ten (10) calendar days from the receipt of the Notice of Award from NPC and in no case later than the signing of the contract.

30.2. The Performance Security shall be denominated in Philippine Pesos and posted in favor of NPC in an amount not less than the percentage of the total contract price in accordance with the following schedule:

Form of Performance Security	Amount of Performance Security (Not less than the Percentage of the Total Contract Price)
(a) Cash or cashier's/manager's check issued by a Universal or Commercial Bank.	Five percent (5%)
(b) Bank draft/guarantee or irrevocable letter of credit issued by a Universal or Commercial Bank: Provided, however, that it shall be confirmed or authenticated by a Universal or Commercial Bank, if issued by a foreign bank.	
(c) Surety bond callable upon demand issued by a surety or insurance company duly certified by the Insurance Commission as authorized to issue such security.	Thirty percent (30%)

30.3. Failure of the successful Bidder to comply with the above-mentioned requirement shall constitute sufficient ground for the annulment of the award and forfeiture of the bid security, in which event NPC shall have a fresh period to initiate and complete the post qualification of the second Lowest Calculated Bid. The procedure shall be repeated until the LCRB is identified and selected for recommendation of contract award. However if no Bidder passed post-qualification, the BAC shall declare the bidding a failure and conduct a re-bidding with re-advertisement, if necessary.

30.4. The performance bond to be posted by the Contractor must also comply with following additional requirements:

1. The following must be indicated in the performance bond to be posted by the Contractor:
  - i. Company Name
  - ii. Correct amount of the Bond
  - iii. Contract/Purchase Order Reference Number
  - iv. Purpose of the Bond:  
 "To guarantee the faithful performance of the Principal's obligation to undertake (Contract/Purchase Order Description) in accordance with the terms and conditions of (Contract No. & Schedule/Purchase Order No.) entered into by the parties."
2. The bond shall remain valid and effective until the duration of the contract (should be specific date reckoned from the contract effectivity)

plus sixty (60) days after NPC's acceptance of the last delivery/final acceptance of the project.

3. In case of surety bond, any extension of the contract duration or delivery period granted to the CONTRACTOR shall be considered as given, and any modification of the contract shall be considered as authorized, as if with the expressed consent of the surety, provided that such extension or modifications falls within the effective period of the said surety bond. However, in the event that the extension of the contract duration or delivery schedule would be beyond the effective period of the surety bond first posted, it shall be the sole obligation of the CONTRACTOR to post an acceptable Performance Security within ten (10) calendar days after the contract duration/delivery period extension has been granted by NPC.
4. Other required conditions in addition to the standard policy terms issued by the Bonding Company:
  - i. The bond is a penal bond, callable on demand and the entire amount thereof shall be forfeited in favor of the Obligee upon default of the Principal without the need to prove or to show grounds or reasons for demand for the sum specified therein;
  - ii. The amount claimed by the Obligee under this bond shall be paid in full and shall never be subject to any adjustment by the Surety;
  - iii. In case of claim, the Surety shall pay such claim within sixty (60) days from receipt by the Surety of the Obligee's notice of claim/demand letter notwithstanding any objection thereto by the Principal.

### **31. Notice to Proceed**

Within seven (7) calendar days from the date of approval of the contract by the appropriate government approving authority, NPC shall issue the Notice to Proceed (NTP) together with a copy or copies of the approved contract to the successful Bidder. All notices called for by the terms of the contract shall be effective only at the time of receipt thereof by the successful Bidder.

### **32. Protest Mechanism**

Decisions of NPC at any stage of the procurement process may be questioned in accordance with Section 55 of the IRR of RA 9184.



## SECTION II

# GENERAL CONDITIONS OF THE CONTRACT



**SECTION II – GENERAL CONDITIONS OF CONTRACT****TABLE OF CONTENTS**

<u>CLAUSE NO.</u>	<u>TITLE</u>	<u>PAGE NO.</u>
1.	DEFINITIONS.....	1
2.	CORRUPT, FRAUDULENT, COLLUSIVE, AND COERCIVE PRACTICES .....	2
3.	INSPECTION AND AUDIT BY THE FUNDING SOURCE.....	3
4.	GOVERNING LAW AND LANGUAGE.....	3
5.	NOTICES.....	3
6.	SCOPE OF CONTRACT.....	4
7.	SUBCONTRACTING .....	7
8.	PROCURING ENTITY'S RESPONSIBILITIES .....	8
9.	PRICES .....	8
10.	PAYMENT .....	8
11.	ADVANCE PAYMENT AND TERMS OF PAYMENT .....	9
12.	TAXES AND DUTIES.....	11
13.	PERFORMANCE SECURITY .....	11
14.	USE OF CONTRACT DOCUMENTS AND INFORMATION.....	12
15.	STANDARDS.....	12
16.	INSPECTION AND TESTS .....	12
17.	WARRANTY.....	13
18.	DELAYS IN THE SUPPLIER'S PERFORMANCE.....	13
19.	LIQUIDATED DAMAGES .....	14
20.	SETTLEMENT OF DISPUTES.....	14
21.	LIABILITY OF THE SUPPLIER .....	15
22.	FORCE MAJEURE .....	15
23.	TERMINATION FOR DEFAULT .....	15
24.	TERMINATION FOR INSOLVENCY.....	16
25.	TERMINATION FOR CONVENIENCE.....	16
26.	TERMINATION FOR UNLAWFUL ACTS.....	17
27.	PROCEDURES FOR TERMINATION OF CONTRACTS .....	17
28.	ASSIGNMENT OF RIGHTS .....	18
29.	CONTRACT AMENDMENT .....	18
30.	APPLICATION .....	18

## SECTION II – GENERAL CONDITIONS OF CONTRACT

### 1. Definitions

1.1. In this Contract, the following terms shall be interpreted as indicated:

- (a) "The Contract" means the agreement entered into between NPC and the Supplier, as recorded in the Contract Form signed by the parties, including all attachments and appendices thereto and all documents incorporated by reference therein.
- (b) "The Contract Price" means the price payable to the Supplier under the Contract for the full and proper performance of its contractual obligations.
- (c) "The Goods" means all of the supplies, equipment, machinery, spare parts, other materials and/or general support services which the Supplier is required to provide to NPC under the Contract.
- (d) "The Services" means those services ancillary to the supply of the Goods, such as transportation and insurance, and any other incidental services, such as installation, commissioning, provision of technical assistance, training, and other such obligations of the Supplier covered under the Contract.
- (e) "GCC" means the General Conditions of Contract contained in this Section.
- (f) NPC is **National Power Corporation (NPC or NAPOCOR)** with office address at BIR Road cor. Quezon Avenue, Diliman, Quezon City.
- (g) "NPC's country" is the Philippines.
- (h) "The Supplier" means the individual contractor, manufacturer distributor, or firm supplying/manufacturing the Goods and Services under this Contract.
- (i) "The Project Site," where applicable, means the place or places named in the Technical Specifications.
- (j) "Day" means calendar day.
- (k) The "Effective Date" of the contract will be the date of signing the contract, however the Supplier shall commence performance of its obligations only upon receipt of the Notice to Proceed and copy of the approved contract.
- (l) "Verified Report" refers to the report submitted by the Implementing Unit to the HoPE setting forth its findings as to the existence of grounds or causes for termination and explicitly stating its recommendation for the issuance of a Notice to Terminate.

## 2. Corrupt, Fraudulent, Collusive, and Coercive Practices

2.1. NPC as well as the bidders, contractors, or suppliers shall observe the highest standard of ethics during the procurement and execution of this Contract. In pursuance of this policy, NPC:

- (a) defines, for the purposes of this provision, the terms set forth below as follows:
  - (i) "corrupt practice" means behavior on the part of officials in the public or private sectors by which they improperly and unlawfully enrich themselves, others, or induce others to do so, by misusing the position in which they are placed, and it includes the offering, giving, receiving, or soliciting of anything of value to influence the action of any such official in the procurement process or in contract execution; entering, on behalf of the Government, into any contract or transaction manifestly and grossly disadvantageous to the same, whether or not the public officer profited or will profit thereby, and similar acts as provided in Republic Act 3019.
  - (ii) "fraudulent practice" means a misrepresentation of facts in order to influence a procurement process or the execution of a contract to the detriment of NPC, and includes collusive practices among Bidders (prior to or after bid submission) designed to establish bid prices at artificial, non-competitive levels and to deprive NPC of the benefits of free and open competition.
  - (iii) "collusive practices" means a scheme or arrangement between two or more Bidders, with or without the knowledge of NPC, designed to establish bid prices at artificial, non-competitive levels.
  - (iv) "coercive practices" means harming or threatening to harm, directly or indirectly, persons, or their property to influence their participation in a procurement process, or affect the execution of a contract;
  - (v) "obstructive practice" is
    - (aa) deliberately destroying, falsifying, altering or concealing of evidence material to an administrative proceedings or investigation or making false statements to investigators in order to materially impede an administrative proceedings or investigation of NPC or any foreign government/foreign or international financing institution into allegations of a corrupt, fraudulent, coercive or collusive practice; and/or threatening, harassing or intimidating any party to prevent it from disclosing its knowledge of matters relevant to the administrative proceedings or

- investigation or from pursuing such proceedings or investigation; or
- (bb) acts intended to materially impede the exercise of the inspection and audit rights of NPC or any foreign government/foreign or international financing institution herein.
- (b) will reject a proposal for award if it determines that the Bidder recommended for award has engaged in any of the practices mentioned in this Clause for purposes of competing for the contract.
- 2.2. Further the Government of the Philippines (GOP) or NPC, as appropriate, will seek to impose the maximum civil, administrative and/or criminal penalties available under the applicable law on individuals and organizations deemed to be involved with any of the practices mentioned in **GCC** Clause 2.1(a).

### 3. Inspection and Audit by the Funding Source

The Supplier shall permit NPC to inspect the Supplier's accounts and records relating to the performance of the Supplier and to have them audited by auditors appointed by the Government of the Philippines (GOP), if so required.

### 4. Governing Law and Language

- 4.1. This Contract shall be interpreted in accordance with the laws of the Republic of the Philippines.
- 4.2. This Contract has been executed in the English language, which shall be the binding and controlling language for all matters relating to the meaning or interpretation of this Contract. All correspondence and other documents pertaining to this Contract exchanged by the parties shall be written in English.

### 5. Notices

- 5.1. Any notice, request, or consent required or permitted to be given or made pursuant to this Contract shall be in writing. Any such notice, request, or consent shall be deemed to have been given or made when received by the concerned party, either in person or through an authorized representative of the Party to whom the communication is addressed, or when sent by registered mail, telex, telegram, or facsimile to such Party at the address specified below, which shall be effective when delivered and duly received or on the notice's effective date, whichever is later.

NPC's address for Notices is:

**FERNANDO MARTIN Y. ROXAS**  
President and CEO  
National Power Corporation  
Gabriel Y. Itchon Building  
Sen. Miriam P. Defensor-Santiago Ave.,  
(formerly BIR Road) cor. Quezon Blvd.,  
Diliman, Quezon City 1100

- 5.2. A Party may change its address for notice hereunder by giving the other Party notice of such change pursuant to the provisions listed in **GCC** Clause 5.1.

## 6. Scope of Contract

- 6.1. The Goods and Related Services to be provided shall be as specified in in **Sections III – Technical Specifications and Section IV – Schedule of Requirements.**
- 6.2. This Contract shall include all such items, although not specifically mentioned, that can be reasonably inferred as being required for its completion as if such items were expressly mentioned herein. Any additional requirements for the completion of this Contract are provided below:

### a. Delivery and Documents –

The delivery terms applicable to the Contract is DDP delivered to the project site specified in the technical specifications, in accordance with INCOTERMS. Risk and title will pass from the Supplier to NPC upon receipt and final acceptance of the Goods at their final destination.

Delivery of the Goods shall be made by the Supplier in accordance with the terms specified in Section III – Technical Specifications. The details of shipping and/or other documents to be furnished by the Supplier are as follows:

*For Goods supplied from within the Philippines*

Upon delivery of the Goods to the Project Site, the Supplier shall notify NPC and present the following documents to NPC:

- (i) Original and four copies of the Supplier's invoice showing Goods' description, quantity, unit price, and total amount;
- (ii) Original and four copies of Supplier's factory test/inspection report;
- (iii) Original and four copies of the certificate of origin (for imported Goods);
- (iv) Delivery receipt detailing number and description of items received signed by NPC's representative at the Project Site;
- (v) Certificate of Completion/Inspection Report signed by NPC's representative at the Project Site;
- (vi) Original and four copies of the Inspection Receiving Report signed by NPC's representative at the Project Site;
- (vii) Original and four copies of the Manufacturer's and/or Supplier's warranty certificate; and
- (viii) Documents specified in the Technical Specifications, if any.

*For Goods supplied from abroad:*

Upon shipment, the Supplier shall notify NPC and the insurance company by e-mail the full details of the shipment, including Contract Number, description of the Goods, quantity, vessel, bill of lading number and date, port of loading, date of shipment, port of discharge etc. Upon delivery to the Project Site, the Supplier shall notify NPC and present the following documents as applicable with the documentary requirements of any letter of credit issued taking precedence:

- (i) Original and four copies of the Supplier's invoice showing Goods' description, quantity, unit price, and total amount;
- (ii) Original and four copies of the negotiable, clean shipped on board bill of lading marked "freight pre-paid" and five copies of the non-negotiable bill of lading;
- (iii) Original and four copies of Supplier's factory test/inspection report;
- (iv) Delivery receipt detailing number and description of items received signed by NPC's representative at the Project Site;
- (v) Certificate of Completion/Inspection Report signed by NPC's representative at the Project Site;
- (vi) Original and four copies of the Inspection Receiving Report signed by NPC's representative at the Project Site;
- (vii) Original and four copies of the certificate of origin (for imported Goods); and
- (viii) Original and four copies of the Manufacturer's and/or Supplier's warranty certificate including all other documents specified in the Technical Specifications, if any.

For purposes of this Clause NPC's Representative at the Project Site is the **VP - Power Engineering Services**

**b. Incidental Services –**

The Supplier is required to provide the following services, including additional services specified in Technical Specifications, if necessary:

- (a) performance or supervision of on-site assembly and/or start-up of the supplied Goods;
- (b) furnishing of tools required for assembly and/or maintenance of the supplied Goods;
- (c) furnishing of a detailed operations and maintenance manual for each appropriate unit of the supplied Goods;

- (d) performance or supervision or maintenance and/or repair of the supplied Goods, for a period of time agreed by the parties, provided that this service shall not relieve the Supplier of any warranty obligations under this Contract; and
- (e) training of NPC's personnel, at the Supplier's plant and/or on-site, in assembly, start-up, operation, maintenance, and/or repair of the supplied Goods.

The Contract price for the Goods shall include the prices charged by the Supplier for incidental services and shall not exceed the prevailing rates charged to other parties by the Supplier for similar services.

**c. Spare Parts –**

The Supplier is required to provide all of the following materials, notifications, and information pertaining to spare parts manufactured or distributed by the Supplier:

- (a) such spare parts as NPC may elect to purchase from the Supplier, provided that this election shall not relieve the Supplier of any warranty obligations under this Contract; and
- (b) in the event of termination of production of the spare parts:
  - i. advance notification to NPC of the pending termination, in sufficient time to permit NPC to procure needed requirements; and
  - ii. following such termination, furnishing at no cost to NPC, the blueprints, drawings, and specifications of the spare parts, if requested.

The spare parts required are listed in the Technical Specifications and the cost thereof are included in the Contract Price.

The Supplier shall carry sufficient inventories to assure ex-stock supply of consumable spares for the Goods for the period specified in the Technical Specifications.

Other spare parts and components shall be supplied as promptly as possible, but in any case within three (3) months of placing the order.

**d. Packaging –**

The Supplier shall provide such packaging of the Goods as is required to prevent their damage or deterioration during transit to their final destination, as indicated in this Contract. The packaging shall be sufficient to withstand, without limitation, rough handling during transit and exposure to extreme temperatures, salt and precipitation during transit, and open storage. Packaging case size and weights shall take into consideration, where appropriate, the remoteness of the GOODS' final destination and the absence of heavy handling facilities at all points in transit.



The packaging, marking, and documentation within and outside the packages shall comply strictly with such special requirements as shall be expressly provided for in the Contract, including additional requirements, if any, specified below, and in any subsequent instructions ordered by NPC.

The outer packaging must be clearly marked on at least four (4) sides as follows:

Name of the Procuring Entity  
Name of the Supplier  
Contract Description  
Final Destination  
Gross weight  
Any special lifting instructions  
Any special handling instructions  
Any relevant HAZCHEM classifications

A packaging list identifying the contents and quantities of the package is to be placed on an accessible point of the outer packaging if practical. If not practical the packaging list is to be placed inside the outer packaging but outside the secondary packaging.

**e. Insurance –**

The Goods supplied under this Contract shall be fully insured by the Supplier in a freely convertible currency against loss or damage incidental to manufacture or acquisition, transportation, storage, and delivery. The Goods remain at the risk and title of the Supplier until their final acceptance by NPC.

**f. Transportation –**

The Supplier is required under Contract to deliver the Goods DDP to the project site. Transport of the Goods to the port of destination in the Philippines, including insurance and storage, as specified in this Contract, shall be arranged and paid for by the Supplier, and the related cost thereof shall be included in the Contract Price.

NPC accepts no liability for the damage of Goods during transit. Risk and title will not be deemed to have passed to NPC until their receipt and final acceptance by NPC at the final destination.

**g. Patent Rights –**

The Supplier shall indemnify NPC against all third-party claims of infringement of patent, trademark, or industrial design rights arising from use of the Goods or any part thereof.

**7. Subcontracting**

- 7.1. Subcontracting of any portion of the Goods, if allowed in the **ITB**, does not relieve the Supplier of any liability or obligation under this Contract. The

Supplier will be responsible for the acts, defaults, and negligence of any subcontractor, its agents, servants or workmen as fully as if these were the Supplier's own acts, defaults, or negligence, or those of its agents, servants or workmen.

- 7.2. If subcontracting is allowed, the Supplier may identify its subcontractor during contract implementation. Subcontractors disclosed and identified during the bidding may be changed during the implementation of this Contract. In either case, subcontractors must submit the documentary requirements under **ITB** Clause 12 and comply with the eligibility criteria specified therein. In the event that any subcontractor is found by NPC to be ineligible, the subcontracting of such portion of the Goods shall be disallowed.

## 8. Procuring Entity's Responsibilities

- 8.1. Whenever the performance of the obligations in this Contract requires that the Supplier obtain permits, approvals, import, and other licenses from local public authorities, NPC shall, if so needed by the Supplier, make its best effort to assist the Supplier in complying with such requirements in a timely and expeditious manner.
- 8.2. NPC shall pay all costs involved in the performance of its responsibilities in accordance with **GCC** Clause 6.

## 9. Prices

- 9.1. For the given scope of work in this Contract as awarded, all bid prices are considered fixed prices, and therefore not subject to price escalation during contract implementation, except under extraordinary circumstances and upon prior approval of the GPPB in accordance with Section 61 of R.A. 9184 and its IRR or except as provided in this Clause.
- 9.2. Prices charged by the Supplier for Goods delivered and/or services performed under this Contract shall not vary from the prices quoted by the Supplier in its bid, with the exception of any change in price resulting from a Change Order issued in accordance with **GCC** Clause 29.

## 10. Payment

- 10.1. Payments shall be made only upon a certification by the HoPE to the effect that the Goods have been rendered or delivered in accordance with the terms of this Contract and have been duly inspected and accepted. Except with the prior approval of the President no payment shall be made for services not yet rendered or for supplies and materials not yet delivered under this Contract. At least one percent (1%) but not to exceed five percent (5%) of the amount of each payment shall be retained by NPC to cover the Supplier's warranty obligations under this Contract as described in **GCC** Clause 17.
- 10.2. The Supplier's request(s) for payment shall be made to NPC in writing, accompanied by an invoice describing, as appropriate, the Goods delivered and/or Services performed, and by documents submitted pursuant to **GCC** Clause 6.2, and upon fulfillment of other obligations stipulated in this Contract.

- 10.3. Pursuant to **GCC** Clause 10.2, payments shall be made promptly by NPC, but in no case later than sixty (60) days after submission of an invoice or claim by the Supplier.
- 10.4. The currency in which payment is made to the Supplier under this Contract shall be in Philippine Pesos.

## 11. Advance Payment and Terms of Payment

- 11.1. Advance payment not to exceed fifteen percent (15%) of the contract amount shall be allowed and paid within sixty (60) calendar days from effectivity of the contract and upon the submission to and acceptance by NPC of an irrevocable letter of credit or bank guarantee issued by a Universal or Commercial Bank. The irrevocable letter of credit or bank guarantee must be for an equivalent amount, shall remain valid until the goods are delivered, and accompanied by a claim for advance payment.
- 11.2. All progress payments shall first be charged against the advance payment until the latter has been fully exhausted.
- 11.3. The terms of payment shall be as follows:
- 1) For Supply and Delivery Contracts:**
- (a) On Contract Effectivity: Advance payment of Fifteen percent (15%) of the total Contract Price shall be paid within sixty (60) days from effectivity of the Contract and upon submission of a claim and an irrevocable letter of credit or bank guarantee issued by a Universal or Commercial Bank for the equivalent amount valid until the Goods are delivered and in the form provided in Section V- Bidding Forms.
- (b) On Delivery: Eighty percent (80%) of the Contract Price of the **delivered Goods** shall be considered for payment, less the total amount of advance payment, if any and other deductions. If the amount is sufficient to fully recoup the advance payment, the remainder after deductions shall be paid to the Supplier within sixty (60) days after the date of receipt of the Goods and upon submission of the documents (i) through (vi) specified in the **GCC** Clause 6.2 provision on Delivery and Documents. Otherwise, the total delivery payment shall be charged against the advance payment and the remaining advance payment will be fully recouped from the succeeding claims.
- (c) On Acceptance: The remaining twenty percent (20%) of the Contract Price of the **delivered Goods** shall be paid to the Supplier within sixty (60) days after the date of submission of the acceptance and inspection certificate for the respective delivery issued by NPC's authorized representative. In the event that no acceptance certificate is issued by NPC's authorized representative within forty five (45) days after successful test and commissioning, if required, the Supplier shall have the right to claim payment of the remaining twenty percent (20%) subject to NPC's own verification of the reason(s) for the failure to issue documents (vii) and (viii) as described in the **GCC** Clause 6.2 provision on Delivery and Documents.

**2) For Supply, Delivery, Installation, Test and Commissioning Contracts:**

- (a) On Contract Effectivity: Advance payment of Fifteen percent (15%) of the total Contract Price shall be paid within sixty (60) days from effectivity of the Contract and upon submission of a claim and an irrevocable letter of credit or bank guarantee issued by a Universal or Commercial Bank for the equivalent amount valid until the Goods are delivered and in the form provided in Section V- Bidding Forms.
- (b) On Delivery: Eighty percent (80%) of the price of the **delivered Goods**, excluding price for installation, test and commissioning shall be considered for payment, less the total amount of advance payment, if any and other deductions. If the amount is sufficient to fully recoup the advance payment, the remainder after deductions shall be paid to the Supplier within sixty (60) days after the date of receipt of the Goods and upon submission of the documents (i) through (vi) specified in the **GCC** Clause 6.2 provision on Delivery and Documents. Otherwise, the total delivery payment shall be charged against the advance payment and the remaining advance payment will be fully recouped from the succeeding claims.
- (c) On Acceptance: The remaining twenty percent (20%) of the price of the **delivered Goods** plus price for installation, test and commissioning shall be paid to the Supplier within sixty (60) days after the date of submission of the acceptance and inspection certificate for the respective delivery issued by NPC's authorized representative. In the event that no acceptance certificate is issued by NPC's authorized representative within forty five (45) days after successful test and commissioning, the Supplier shall have the right to claim payment subject to NPC's own verification of the reason(s) for the failure to issue documents (vii) and (viii) as described in the **GCC** Clause 6.2 provision on Delivery and Documents.

**3) For Supply, Delivery, Installation, Test and Commissioning Contracts where Installation, Test and Commissioning prices are included in the supply price:**

- (a) On Contract Effectivity: Advance payment of Fifteen percent (15%) of the total Contract Price shall be paid within sixty (60) days from effectivity of the Contract and upon submission of a claim and an irrevocable letter of credit or bank guarantee issued by a Universal or Commercial Bank for the equivalent amount valid until the Goods are delivered and in the form provided in Section V- Bidding Forms.
- (b) On Delivery: Sixty percent (60%) of the price of the **delivered Goods** shall be considered for payment, less the total amount of advance payment, if any and other deductions. If the amount is sufficient to fully recoup the advance payment, the remainder after deductions shall be paid to the Supplier within sixty (60) days after the date of receipt of the Goods and upon submission of the documents (i) through (vi) specified in the **GCC** Clause 6.2 provision on Delivery and Documents. Otherwise, the total delivery payment shall be charged against the advance payment and

the remaining advance payment will be fully recouped from the succeeding claims.

- (c) On Acceptance: The remaining forty percent (40%) of the price of the **delivered Goods** shall be paid to the Supplier within sixty (60) days after the date of submission of the acceptance and inspection certificate for the respective delivery issued by NPC's authorized representative. In the event that no acceptance certificate is issued by NPC's authorized representative within forty five (45) days after successful test and commissioning, the Supplier shall have the right to claim payment subject to NPC's own verification of the reason(s) for the failure to issue documents (vii) and (viii) as described in the **GCC** Clause 6.2 provision on Delivery and Documents.

## 12. Taxes and Duties

The Supplier, whether local or foreign, shall be entirely responsible for all the necessary taxes, stamp duties, license fees, and other such levies imposed for the completion of this Contract.

## 13. Performance Security

- 13.1. Within ten (10) calendar days from receipt of the Notice of Award from NPC but in no case later than the signing of the contract by both parties, the successful Bidder shall furnish the performance security in any the forms prescribed in the **ITB** Clause 30.2.
- 13.2. The performance security posted in favor of NPC shall be forfeited in the event it is established that the winning bidder is in default in any of its obligations under the contract.
- 13.3. The performance security shall remain valid until issuance by NPC of the Certificate of Final Acceptance.
- 13.4. The performance security may be released by NPC and returned to the Supplier after the issuance of the Certificate of Final Acceptance subject to the following conditions:
- (a) There are no pending claims against the Supplier or the surety company filed by NPC;
  - (b) The Supplier has no pending claims for labor and materials filed against it;
- 13.5. In case of a reduction of the contract value, NPC shall allow a proportional reduction in the original performance security, provided that any such reduction is more than ten percent (10%) and that the aggregate of such reductions is not more than fifty percent (50%) of the original performance security.

#### 14. Use of Contract Documents and Information

- 14.1. The Supplier shall not, except for purposes of performing the obligations in this Contract, without NPC's prior written consent, disclose this Contract, or any provision thereof, or any specification, plan, drawing, pattern, sample, or information furnished by or on behalf of NPC. Any such disclosure shall be made in confidence and shall extend only as far as may be necessary for purposes of such performance.
- 14.2. Any document, other than this Contract itself, enumerated in **GCC Clause 14.1** shall remain the property of NPC and shall be returned (all copies) to NPC on completion of the Supplier's performance under this Contract if so required by NPC.

#### 15. Standards

The Goods provided under this Contract shall conform to the standards mentioned in the **Section III – Technical Specifications**; and, when no applicable standard is mentioned, to the authoritative standards appropriate to the Goods' country of origin. Such standards shall be the latest issued by the institution concerned.

#### 16. Inspection and Tests

- 16.1. NPC or its representative shall have the right to inspect and/or to test the Goods to confirm their conformity to the Contract specifications at no extra cost to NPC. The **Section III – Technical Specifications** shall specify what inspections and/or tests NPC requires and where they are to be conducted. NPC shall notify the Supplier in writing, in a timely manner, of the identity of any representatives retained for these purposes.
- 16.2. If applicable, the inspections and tests may be conducted on the premises of the Supplier or its subcontractor(s), at point of delivery, and/or at the goods' final destination. If conducted on the premises of the Supplier or its subcontractor(s), all reasonable facilities and assistance, including access to drawings and production data, shall be furnished to the inspectors at no charge to NPC. The Supplier shall provide NPC with results of such inspections and tests.
- 16.3. NPC or its designated representative shall be entitled to attend the tests and/or inspections referred to in this Clause provided that NPC shall bear all of its own costs and expenses incurred in connection with such attendance including, but not limited to, all traveling and board and lodging expenses.
- 16.4. NPC may reject any Goods or any part thereof that fail to pass any test and/or inspection or do not conform to the specifications. The Supplier shall either rectify or replace such rejected Goods or parts thereof or make alterations necessary to meet the specifications at no cost to NPC, and shall repeat the test and/or inspection, at no cost to NPC, upon giving a notice pursuant to **GCC Clause 5**.
- 16.5. The Supplier agrees that neither the execution of a test and/or inspection of the Goods or any part thereof, nor the attendance by NPC or its

representative, shall release the Supplier from any warranties or other obligations under this Contract.

## 17. Warranty

- 17.1. The Supplier warrants that the Goods supplied under the Contract are new, unused, of the most recent or current models, and that they incorporate all recent improvements in design and materials, except when the technical specifications required by NPC provides otherwise.
- 17.2. The Supplier further warrants that all Goods supplied under this Contract shall have no defect, arising from design, materials, or workmanship or from any act or omission of the Supplier that may develop under normal use of the supplied Goods in the conditions prevailing in the country of final destination.
- 17.3. In order to assure that manufacturing defects shall be corrected by the Supplier, a warranty shall be required from the Supplier for a minimum period specified in Section III – Part I (Technical Specifications). The obligation for the warranty shall be covered by, at the Supplier's option, either retention money in an amount equivalent to at least one percent (1%) but not to exceed five percent (5%) of every progress payment, or a special bank guarantee equivalent to at least one percent (1%) but not to exceed five percent (5%) of the total Contract Price. The said amounts shall only be released after the lapse of the warranty period specified in Section III – Part I (Technical Specifications); provided, however, that the Supplies delivered are free from patent and latent defects and all the conditions imposed under this Contract have been fully met.

Certificate of Acceptance of the entire contract shall be issued only after complete delivery, inspection, test (if required) and acceptance of all Goods and services required in the contract

- 17.4. NPC shall promptly notify the Supplier in writing of any claims arising under this warranty. Upon receipt of such notice, the Supplier shall, within the period not exceed thirty (30) days upon receipt of the notice from NPC and with all reasonable speed, correct/repair or replace the defective Goods or parts thereof, without cost to NPC.
- 17.5. If the Supplier, having been notified, fails to remedy the defect(s) within the period specified in **GCC** Clause 17.4, NPC may proceed to take such remedial action as may be necessary, at the Supplier's risk and expense and without prejudice to any other rights which NPC may have against the Supplier under the Contract and under the applicable law.

## 18. Delays in the Supplier's Performance

- 18.1. Delivery of the Goods and/or performance of Services shall be made by the Supplier in accordance with the time schedule prescribed by NPC in **Section III – Technical Specifications**.
- 18.2. If at any time during the performance of this Contract, the Supplier or its Subcontractor(s) should encounter conditions impeding timely delivery of the Goods and/or performance of Services, the Supplier shall promptly notify

NPC in writing of the fact of the delay, its likely duration and its cause(s). As soon as practicable after receipt of the Supplier's notice, and upon causes provided for under **GCC** Clause 22, NPC shall evaluate the situation and may extend the Supplier's time for performance, in which case the extension shall be ratified by the parties by amendment of Contract.

- 18.3. Except as provided under **GCC** Clause 22, a delay by the Supplier in the performance of its obligations shall render the Supplier liable to the imposition of liquidated damages pursuant to **GCC** Clause 19, unless an extension of time is agreed upon pursuant to **GCC** Clause 29 without the application of liquidated damages.

## 19. Liquidated Damages

- 19.1. When the supplier fails to satisfactorily deliver any or all of the Goods and/or to perform the Services within the specified delivery schedule, inclusive of duly granted time extensions, if any, the supplier shall be liable for damages for the delay and shall pay the procuring entity liquidated damages, not by way of penalty, an amount equal to one-tenth (1/10) of one percent (1%) of the cost of the delayed goods scheduled for delivery for every day of delay until such goods are finally delivered and accepted by the procuring entity concerned. The procuring entity need not prove that it has incurred actual damages to be entitled to liquidated damages. Such amount shall be deducted from any money due or which may become due to the supplier, or collected from any securities or warranties posted by the supplier, whichever is convenient to the procuring entity concerned. In case the total sum of liquidated damages reaches ten percent (10%) of the total contract price, the procuring entity concerned may rescind the contract and impose appropriate sanctions over and above the liquidated damages to be paid.

## 20. Settlement of Disputes

- 20.1. If any dispute or difference of any kind whatsoever shall arise between NPC and the Supplier in connection with or arising out of this Contract, the parties shall make every effort to resolve amicably such dispute or difference by mutual consultation.
- 20.2. If after thirty (30) days, the parties have failed to resolve their dispute or difference by such mutual consultation, then either NPC or the Supplier may give notice to the other party of its intention to commence arbitration, as hereinafter provided, as to the matter in dispute, and no arbitration in respect of this matter may be commenced unless such notice is given.
- 20.3. Any dispute or difference in respect of which a notice of intention to commence arbitration has been given in accordance with this Clause shall be settled by arbitration. Arbitration may be commenced prior to or after delivery of the Goods under this Contract.
- 20.4. In the case of a dispute between NPC and the Supplier, the dispute shall be resolved in accordance with Republic Act 9285 ("R.A. 9285"), otherwise known as the "Alternative Dispute Resolution Act of 2004."



20.5. Notwithstanding any reference to arbitration herein, the parties shall continue to perform their respective obligations under the Contract unless they otherwise agree; and NPC shall pay the Supplier any monies due the Supplier.

## 21. Liability of the Supplier

21.1. The Supplier's liability under this Contract shall be as provided by the laws of the Republic of the Philippines. For joint venture, all partners to the joint venture shall be jointly and severally liable to NPC.

21.2. Except in cases of criminal negligence or willful misconduct, and in the case of infringement of patent rights, if applicable, the aggregate liability of the Supplier to NPC shall not exceed the total Contract Price, provided that this limitation shall not apply to the cost of repairing or replacing defective equipment.

## 22. Force Majeure

22.1. The Supplier shall not be liable for forfeiture of its performance security, liquidated damages, or termination for default if and to the extent that the Supplier's delay in performance or other failure to perform its obligations under the Contract is the result of a *force majeure*.

22.2. For purposes of this Contract the terms "*force majeure*" and "fortuitous event" may be used interchangeably. In this regard, a fortuitous event or *force majeure* shall be interpreted to mean an event which the Supplier could not have foreseen, or which though foreseen, was inevitable. It shall not include ordinary unfavorable weather conditions; and any other cause the effects of which could have been avoided with the exercise of reasonable diligence by the Supplier. Such events may include, but not limited to, acts of NPC in its sovereign capacity, wars or revolutions, fires, floods, epidemics, quarantine restrictions, and freight embargoes.

22.3. If a *force majeure* situation arises, the Supplier shall promptly notify NPC in writing of such condition and the cause thereof. Unless otherwise directed by NPC in writing, the Supplier shall continue to perform its obligations under the Contract as far as is reasonably practical, and shall seek all reasonable alternative means for performance not prevented by the *force majeure*.

## 23. Termination for Default

23.1. NPC may rescind or terminate a contract for default, without prejudice to other courses of action and remedies available under the circumstances when, outside of *force majeure*, the Supplier fails to deliver or perform any or all of the Goods within the period(s) specified in the contract, or within any extension thereof granted by NPC pursuant to a request made by the Supplier prior to the delay, and such failure amounts to at least ten percent (10%) of the contract price.

23.2. NPC may terminate the contract when, as a result of *force majeure*, the Supplier is unable to deliver or perform any or all of the Goods, amounting to at least ten percent (10%) of the contract price, for a period of not less than sixty (60) calendar days after receipt of the notice from NPC stating that the circumstance of force majeure is deemed to have ceased.

- 23.3. NPC shall terminate the contract when the Supplier fails to perform any other obligation under the Contract.
- 23.4. In the event NPC terminates this Contract in whole or in part, for any of the reasons provided under **GCC** Clauses 23 to 26, NPC may procure, upon such terms and in such manner as it deems appropriate, Goods or Services similar to those undelivered, and the Supplier shall be liable to NPC for any excess costs for such similar Goods or Services. However, the Supplier shall continue performance of this Contract to the extent not terminated.
- 23.5. In case the delay in the delivery of the Goods and/or performance of the Services exceeds a time duration equivalent to ten percent (10%) of the specified contract time plus any time extension duly granted to the Supplier, NPC may terminate this Contract, forfeit the Supplier's performance security and award the same to a qualified Supplier.

#### **24. Termination for Insolvency**

NPC shall terminate this Contract if the Supplier is declared bankrupt or insolvent as determined with finality by a court of competent jurisdiction. In this event, termination will be without compensation to the Supplier, provided that such termination will not prejudice or affect any right of action or remedy which has accrued or will accrue thereafter to NPC and/or the Supplier.

#### **25. Termination for Convenience**

- 25.1. NPC may terminate this Contract, in whole or in part, at any time for its convenience. The HoPE may terminate a contract for the convenience of the Government if he has determined the existence of conditions that make Project Implementation economically, financially or technically impractical and/or unnecessary, such as, but not limited to, fortuitous event(s) or changes in law and national government policies.
- 25.2. The Goods that have been delivered and/or performed or are ready for delivery or performance within thirty (30) calendar days after the Supplier's receipt of Notice to Terminate shall be accepted by NPC at the contract terms and prices. For Goods not yet performed and/or ready for delivery, NPC may elect:
- (a) to have any portion delivered and/or performed and paid at the contract terms and prices; and/or
  - (b) to cancel the remainder and pay to the Supplier an agreed amount for partially completed and/or performed goods and for materials and parts previously procured by the Supplier.
- 25.3. If the Supplier suffers loss in its initial performance of the terminated contract, such as purchase of raw materials for goods specially manufactured for NPC which cannot be sold in open market, it shall be allowed to recover partially from this Contract, on a *quantum meruit* basis. Before recovery may be made, the fact of loss must be established under oath by the Supplier to the satisfaction of NPC before recovery may be made.

## 26. Termination for Unlawful Acts

26.1. NPC may terminate this Contract in case it is determined *prima facie* that the Supplier has engaged, before or during the implementation of this Contract, in unlawful deeds and behaviors relative to contract acquisition and implementation. Unlawful acts include, but are not limited to, the following:

- (a) Corrupt, fraudulent, and coercive practices as defined in **ITB** Clause 3.1(a);
- (b) Drawing up or using forged documents;
- (c) Using adulterated materials, means or methods, or engaging in production contrary to rules of science or the trade; and
- (d) Any other act analogous to the foregoing.

## 27. Procedures for Termination of Contracts

27.1. The following provisions shall govern the procedures for termination of this Contract:

- (a) Upon receipt of a written report of acts or causes which may constitute ground(s) for termination as aforementioned, or upon its own initiative, the Implementing Unit shall, within a period of seven (7) calendar days, verify the existence of such ground(s) and cause the execution of a Verified Report, with all relevant evidence attached;
- (b) Upon recommendation by the Implementing Unit, the HoPE shall terminate this Contract only by a written notice to the Supplier conveying the termination of this Contract. The notice shall state:
  - (i) that this Contract is being terminated for any of the ground(s) afore-mentioned, and a statement of the acts that constitute the ground(s) constituting the same;
  - (ii) the extent of termination, whether in whole or in part;
  - (iii) an instruction to the Supplier to show cause as to why this Contract should not be terminated; and
  - (iv) special instructions of NPC, if any.
- (c) The Notice to Terminate shall be accompanied by a copy of the Verified Report;
- (d) Within a period of seven (7) calendar days from receipt of the Notice of Termination, the Supplier shall submit to the HoPE a verified position paper stating why this Contract should not be terminated. If the Supplier fails to show cause after the lapse of the seven (7) day period, either by inaction or by default, the HoPE shall issue an order terminating this Contract;
- (e) NPC may, at any time before receipt of the Supplier's verified position paper described in item (d) above withdraw the Notice to Terminate if it is determined that certain items or works subject of the notice had

been completed, delivered, or performed before the Supplier's receipt of the notice;

- (f) Within a non-extendible period of ten (10) calendar days from receipt of the verified position paper, the HoPE shall decide whether or not to terminate this Contract. It shall serve a written notice to the Supplier of its decision and, unless otherwise provided, this Contract is deemed terminated from receipt of the Supplier of the notice of decision. The termination shall only be based on the ground(s) stated in the Notice to Terminate;
- (g) The HoPE may create a Contract Termination Review Committee (CTRC) to assist him in the discharge of this function. All decisions recommended by the CTRC shall be subject to the approval of the HoPE; and
- (h) The Supplier must serve a written notice to NPC of its intention to terminate the contract at least thirty (30) calendar days before its intended termination. The Contract is deemed terminated if it is not resumed in thirty (30) calendar days after the receipt of such notice by NPC.

**28. Assignment of Rights**

The Supplier shall not assign his rights or obligations under this Contract, in whole or in part, except with NPC's prior written consent.

**29. Contract Amendment**

Subject to applicable laws, no variation in or modification of the terms of this Contract shall be made except by written amendment signed by the parties.

**30. Application**

These General Conditions shall apply to the extent that they are not superseded by provisions of other parts of this Contract.

## **SECTION III**

# **TECHNICAL SPECIFICATIONS**

**PART I – TECHNICAL SPECIFICATIONS**

**PART II – TECHNICAL DATA SHEETS**

**TECHNICAL SPECIFICATIONS****EW - ELECTRICAL WORKS****TABLE OF CONTENTS**

<u>CLAUSE NO.</u>	<u>TITLE</u>	<u>PAGE NO.</u>
TS-1.0	GENERAL.....	1
TS-2.0	SCOPE OF WORK.....	1
TS-3.0	DELIVERY PERIOD AND LOCATION.....	2
TS-4.0	STANDARD OF MATERIALS.....	2
TS-5.0	TECHNICAL REQUIREMENTS .....	3
TS-5.1	STRONG MOTION ACCELEROMETERS (SMA) .....	3
TS-5.2	STANDPIPE PIEZOMETER (SPP) .....	3
TS-5.3	IP COMMUNICATION RADIO.....	4
TS-5.4	INTEGRATED SOLAR LIGHT .....	4
TS-6.0	PREPARATORY AND INSTALLATION WORKS .....	5
TS-6.1	Preparatory Works.....	5
TS-6.2	Installation Works .....	6
TS-7.0	TESTING AND COMMISSIONING.....	6
TS-7.1	Requirement of Adjustment and Test.....	6
TS-7.2	Work Assembly Tests .....	7
TS-7.3	Design/ Routine/ Type Tests Report.....	7
TS-7.4	Commissioning and Joint Final Inspection (JFI).....	7
TS-8.0	WARRANTY .....	8
TS-9.0	SUPPORT SERVICES .....	8
TS-10.0	ACCEPTANCE CRITERIA.....	8
TS-11.0	DATA AND DOCUMENTS TO BE SUBMITTED.....	8
TS-12.0	TRAINING OF NPC PERSONNEL.....	10
TS-13.0	MEASUREMENT OF PAYMENT .....	10

## SECTION III – TECHNICAL SPECIFICATIONS

### PART I – TECHNICAL SPECIFICATIONS

#### TS-1.0 GENERAL

This section covers the technical and associated requirements for the complete system for the Rehabilitation/Restoration of Dam Instrumentations of Angat Dam Main and Secondary Dykes located in San Lorenzo, Norzagaray, Bulacan.

All support shall be suitable for the intended purpose and shall comply with all applicable regulations, quality and standards. The Supplier shall submit all related drawings and document deemed necessary, prior to the execution of the work, subject to the approval of NPC.

The works shall be performed and completed in a satisfactory manner in accordance with generally accepted modern engineering practice.

#### TS-2.0 SCOPE OF WORK

The works to be done under this specification and other associated requirements shall generally include the rehabilitation/restoration, testing and commissioning of instrumentation devices of Angat Dam Main and Secondary Dykes but not limited to the following:

1. Conduct site inspection for the determination of station location, equipment identification and compatibility analysis;
2. Restoration/reconnection, Test and Commissioning of:
  - a. Strong Motion Accelerometers complete with required accessories and appurtenances for the complete and reliable operation of the system;
  - b. Solar Panel set and power cables;
  - c. Standpipe Piezometer instruments to the Data Logger to be supplied;
  - d. Communication devices and software to be integrated with the existing system. Contractor shall ensure system compatibility of each supplied equipment and/or devices to suit actual site requirement and shall ensure real-time monitoring of all instruments;
  - e. IP Radio Communication System;
  - f. LED Lighting system with sensor-switching capability including power conductors and other appurtenances required for the interfacing of supplied LED lighting;
3. Supply of Data Logger and required accessories;
4. Conduct of Propagation Testing;
5. Testing and Commissioning of Communication System;
6. Conduct admin and user training of NPC personnel regarding operation and maintenance of the supplied equipment including system configuration, setting and parameterization; and,
7. Provide technical assistance and services during the warranty period such as periodic assessment of the operating condition. This



include all maintenance services to be rendered upon request in the event of any abnormality occurred within the warranty period.

8. Reconstruction/restructuring and setting of damaged SMA/SPP housing/enclosure.

The work shall also include all the other works and services which are not indicated on the technical specifications that are necessary for the complete and reliable operation of the system shall hereby provide by the Supplier.

#### **TS-3.0 DELIVERY PERIOD AND LOCATION**

The delivery period shall be **NINETY (90) CALENDAR DAYS** reckoned upon receipt of Notice to Proceed (NTP).

The materials and equipment to be supplied shall be delivered to **ANGAT DAM, SAN LORENZO, NORZAGARAY, BULACAN.**

#### **TS-4.0 STANDARD OF MATERIALS**

All materials to be used in the work shall be new, of high quality, free from all defects and of proven acceptability for the purpose of intended. Unless otherwise specified, materials shall conform to the latest applicable standard issued by the following authorities:

- |   |      |
|---|------|
| 1. American National Standards Institute            | ANSI |
| 2. Institute of Electrical and Electronic Engineers | IEEE |
| 3. American Society for Testing and Materials       | ASTM |
| 4. National Electrical Manufacturer's Association   | NEMA |
| 5. Underwriters Laboratory                          | UL   |
| 6. International Electro-Technical Commission       | IEC  |
| 7. International Standards Organization             | ISO  |
| 8. National Electrical Code                         | NEC  |
| 9. National Electrical Safety Code                  | NESC |
| 10. Philippine Electrical Code                      | PEC  |
| 11. Illuminating Engineering Society                | IES  |
| 12. Philippine National Standards                   | PNS  |

These codes and standards set forth the minimum requirements which may be exceeded by the Supplier, if, in the Contractor/ Supplier's judgment and with NPC's acceptance, superior or more economical designs or materials are available for successful and continuous operation of the Supplier's equipment as required by this specification.





The equipment furnished shall be in accordance with, but not limited to, the latest issues of the applicable Codes and Standards, including all addenda, in effect at time of purchase order unless otherwise stated in the specification.

## **TS-5.0 TECHNICAL REQUIREMENTS**

### **General**

This section describes the technical specifications of all materials and equipment to be furnished by the Supplier.

The specification covers the Rehabilitation/Restoration of Dam Instrumentation of Angat Dam Main and Secondary Dykes located in San Lorenzo, Norzagaray, Bulacan.

The specification is not intended to give all the details or to describe all the aspects of the scope of works which may include all equipment necessary to ensure that the equipment supplied and installed is complete and ready for operation.

The work required herein including all works and services although not specifically mentioned and detailed but are required for the complete, safe and reliable operation shall be provided by the Supplier.

The Supplier shall install furnished equipment in a neat and high-quality satisfactory manner in conformance with modern engineering method and practice.

The Supplier shall meet the minimum requirements specified in the technical requirements. Non-compliance will be ground for disqualification.

## **TS-5.1 STRONG MOTION ACCELEROMETERS (SMA)**

The affected one (1) SMA unit shall be restored/reconnected on site and shall work correctly and reliably to its designated function.

Four (4) SMA's shall be integrated with a photocell-controlled LED lighting fixture. Instrument piers, housing/enclosure must be watertight, and access shall be secured from theft/unauthorized access. Spare batteries shall be supplied.

SMA's shall be able to transmit data and provide access to waveform monitoring, viewing and direct downloading of events via ethernet, calibration, configuration and maintenance through the wireless communication system.

## **TS-5.2 STANDPIPE PIEZOMETER (SPP)**

Three (3) affected SPPs shall be restored/reconnected to the station data logger to be supplied and shall work correctly and reliably to their designated function. It shall be able to transmit data wirelessly through the IP Communication system.



Two (2) SPP stations shall be integrated with a photocell-controlled LED lighting fixture. Instrument piers, housing/enclosure must be watertight, and access shall be secured from theft/unauthorized access. Spare batteries shall be supplied.

The minimum specifications of the Data Logger shall be as follow:

1. Data Logger	
a. Channel Capacity	At least 3
b. Accuracy	±0.05%
c. Operating Temperature	50°C
d. Scan Interval	24 hours
e. Connection	10-Pin Connector, 6-Pin Waterproof Connector, RS-232/USB/RS-485

**TS-5.3****IP COMMUNICATION RADIO**

The IP Communication Radio shall be capable of transmitting and receiving data and information reliably using a point-to-multipoint (PTMP) / point-to-point (PTP) system on designated areas of Angat Dam.

IP Communication Radio housing/enclosure shall be protected from unauthorized access.

The minimum specifications of the IP Communication Radio shall be as follows:

Description	Requirements
1. Frequency	5GHz
2. Channel Bandwidth	5, 10, 20 or 40MHz
3. Operating Temperature	Up to 60°C
4. Standards Compliance	IEC
5. Communication Interface	IPV4/IPV6,HTTP,100/1000 Base T
6. Power Supply	POE
7. Physical Layer	2x2 MIMO/OFDM
8. Wind Survival	Up to 145 kph
9. Protection	At least IP55 Rating
10. Encryption	128-bit AES

**TS-5.4****INTEGRATED SOLAR LIGHT**

Solar LED lighting system shall be self-powered and to be compose of a built-in lithium iron phosphate battery, intelligent controller, and a monocrystalline solar panel.

It shall be composed of a photoelectric and sensor-controlled switching system. The sensor shall detect presence of activity/movement in the area. Illumination shall dim if no activity/motion is detected, maximum illumination shall be set manually.



The Solar LED lighting system shall be integrated with the supplied instrumentation system and to be attached to the equipment installation poles thru mounting brackets. The following specifications are required:

Description	Requirements
1. Solar Panel Parameters	
a. Rated Power, W	110
b. Rated Voltage, Vdc	18
2. Battery Parameters	
a. Type	LiFePO4
b. Rated Voltage, V	12.8
c. Ampacity, Ah	51
3. Rated Power, W	80
4. Charge Time, h	4
5. Protection	IP66
6. Operating Temperature, deg C	Up to 60
7. Luminous Flux, lm	13,600
8. Lighting Mode	Variable

## TS-6.0 PREPARATORY AND INSTALLATION WORKS

### TS-6.1 Preparatory Works

#### General

The works to be done shall consist of the following items:

1. Survey and Investigation
2. Transportation and Storage

The works to be done shall be conducted to prepare for the installation of instrumentation and telecommunications equipment. All expenses necessary for the preparatory works shall be included in the contact price.

#### Survey and investigation

Survey and investigation shall be conducted at each job site to obtain information such as road condition, site condition and civil works condition.

#### Transportation and storage

Transportation shall mean carrying the instrumentation and telecommunication equipment and materials from the supplier's stockroom/stockyard to each job site.

Storage shall mean keeping the instrumentation and telecommunications equipment and materials in the stockroom and stockyard of NPC.



**TS-6.2 Installation Works****General**

The Supplier shall carry out all the installation works as specified in the Technical Specifications, or as directed by NPC, by furnishing all labor, materials and equipment to complete the Installation works in accordance with the specification and as per industry standard.

The Supplier shall provide complete details of proper handling, transport and storage, installation, testing, performance guarantees, etc.

The Supplier shall ensure that the equipment is installed in accordance with manufacturer's recommendations, check control system hardware and software configuration, perform logic configuration changes or additions, perform tuning adjustments necessary to place the system in trouble free operation. Instruct the operating personnel in the proper operation and maintenance of the equipment furnished, perform hardware trouble shooting and/or installation. An experienced engineer/service technician, as a minimum, is required for this task.

**TS-7.0 TESTING AND COMMISSIONING****TS-7.1 Requirement of Adjustment and Test**

In accordance with the standard and specifications, the Supplier shall be required to submit, for approval the test program describing each test and adjustment to be perform together with the time and manpower schedule that will conduct the test. The program of the test on completion shall define the sequence of test, equipment to be used, equipment operation procedure and detailed procedure of conducting the test. Moreover, shall contain the design values, technical particulars or any other standard data for testing which shall be treated as the criteria for the evaluation of such test.

Experienced and skilled engineers and technicians along this line shall be required from the Supplier for the adjustment and test.

The following are the major adjustment items:

1. Adjustment of individual equipment at each site.
  - a. Visual Inspection of high-quality satisfactory of mounting, cabling, and wiring, physical inventory of system stations and equipment;
  - b. System performance and characteristic test; and,
  - c. Electrical Characteristics
2. Overall adjustment of the whole system.
  - a. Overall Operation
  - b. Function

**TS-7.2 Work Assembly Tests****General**

The instrumentation and telecommunications equipment to be furnished shall be completely assembled and adjusted at the Supplier's workshop and routine shop tests and another test will be made. All parts shall be properly marked for ease of assembly in the field. All tests required herein shall be witnessed by NPC or his authorized representative unless waived in writing, and no equipment shall be installed until released for delivery by NPC authorized representative.

The test equipment, test methods, measurements and computations shall be in accordance with the latest applicable requirements of ANSI and IEC Standard except in cases where otherwise set forth and shall be subject to the approval of NPC.

**Shop Test**

Routine, design, quality conformance tests and other tests necessary shall be performed in accordance with ANSI Standard or equivalent IEC Standard.

The Supplier shall make all preparation for tests and provides the test apparatus and personnel and shall notify NPC the date of the test ten (10) days in advance.

The tests noted below shall be performed and may be witnessed by NPC authorized representative on the equipment covered by the Specification at the Manufacturer's plant before shipment.

**TS-7.3 Design/ Routine/ Type Tests Report**

The Supplier shall submit certified copy of the results of design/ routine/ type tests on each type of equipment to show the adequacy of its design and manufacturing quality.

The Supplier shall furnish a detailed description of the test, test procedures and results.

**TS-7.4 Commissioning and Joint Final Inspection (JFI)**

In accordance with the standard and specification, the Supplier shall be required to submit the detailed site acceptance test parameter, checklist, punch list, generated punch list if there are any, system test parameters, site cleanup checklist, describing each test and adjustment to be performed together with the time and manpower schedule prior to the conduct of JFI.

Test on completion shall be done in the presence of NPC representatives. Inspection shall include, but not limited to the following:

1. At each site:
  - a. Visual Inspection of high-quality satisfactory of mounting, cabling, and wiring, physical inventory of system stations and equipment;

- b. System performance and characteristic test; and,
- c. Electrical Characteristics

2. Overall Test for the Whole System:
  - a. Overall Operation
  - b. Function

Any corrective works, deficiency findings or not in accordance with required specifications will form part of the punch list items that will be generated after the conduct of JFI. The punch list items must be complied and accepted by NPC prior to the issuance of Certificate of Completion of Works. The date of acceptance of the compliance report will determine the completion of the project.

#### **TS-8.0 WARRANTY**

Full equipment warranty period of the system is One (1) Year from the date of issuance of Certificate of Completion of Works (Final Acceptance) of the project.

The Supplier shall provide Manufacturer Certificate of Warranty & Support for the following:

1. Telemetry Equipment including application software
2. Point-to-Point (P2P) IP-radio Equipment

The Supplier shall remedy, at his own expense, any defects against which the equipment is guaranteed, by making all necessary repair or replacement.

#### **TS-9.0 SUPPORT SERVICES**

During the warranty period, the Supplier must have **Remote Support Services** to support its clients in the system administration, monitoring, maintenance, and repair operations free of charge.

#### **TS-10.0 ACCEPTANCE CRITERIA**

Acceptance certificate shall be issued only after all the items are completely delivered, inspected, tested and found to conform to the specifications. If any, fail to pass the inspection and actual testing, End-user may at its own judgment, direct the Supplier to replace within the period of sixty (60) calendar days as the goods in question.

#### **TS-11.0 DATA AND DOCUMENTS TO BE SUBMITTED**

- a. To be submitted with the bid/proposal for evaluation:
  - a.1 Completely filled-out Technical Data Sheets (TDS);
  - a.2 Original Copy of Manufacturer/ Distributor Authorization to Bid, directly addressed to the BAC-NPC, indicating therein the PR/ Reference number;

In case of authorized Distributor issuing the authority to bid, it shall be accompanied by a Certificate of Authorized Distributorship from the Manufacturer.

*Note: Authorization to Bid and Certificate of Distributorship from the Manufacturer shall be current and valid on the date of bid opening as advertised.*

- a.3 Antenna Design.
- b. To be submitted during post qualification:
  - b.1 Certification from Manufacturer's main/regional office stating that the contractor is an Authorized Business Partner of the brand being offered;
  - b.2 Letter of Confirmation from the Manufacturer that a local agent or representative is available to provide "After Sales Service" to the supplied components/parts/accessories during and after the warranty period. Name, address and contact number shall be provided;
  - b.3 Manufacturer's Brochures/Catalogues/Drawings which contain information/data to support the Supplier's submitted and filled-out Technical Data Sheet;

*Note: Authorization to bid shall be current and valid for at least Six (6) months from the date of bid opening as advertised.*

- c. To be submitted before or upon delivery:
  - c.1 **"Certificate of Origin" from the Original Equipment Manufacturer;**
  - c.2 **"Warranty Certificate" for one (1) year against factory defects/satisfactory;**
  - c.3 **Quality Assurance or Quality Inspection Certificate from the Manufacturer and;**
  - c.4 **Installation Manual.**

**All drawings and documents in Clause TS-11.0 item c shall be submitted to the Manager – DMD or to the NPC Angat Dam Person-In-Charge for evaluation and/or approval prior to issuance of acceptance.**

**TS-12.0 TRAINING OF NPC PERSONNEL**

The Bidder shall conduct three (3) days of comprehensive training for the complete use of the equipment for at least four (4) NPC DMD personnel. The training shall cover the equipment's testing functionalities, operation, troubleshooting, and maintenance.

The Bidder shall provide hard and PDF copies of the English instruction manuals of the equipment.

**TS-13.0 MEASUREMENT OF PAYMENT**

Payment will be made at the contract price in the Schedule of Requirements and thereof shall constitute the full compensation for the supply, installation, propagation testing and commissioning of the equipment/ component including accessories.



**SECTION III – TECHNICAL SPECIFICATIONS****PART II – TECHNICAL DATA SHEETS****TABLE OF CONTENTS**

<b>SECTION</b>	<b>DESCRIPTION</b>	<b>PAGE</b>
1.0	REHABILITATION/RESTORATION OF DAM INSTRUMENTATIONS OF ANGAT DAM MAIN AND SECONDARY DYKES LOCATED IN SAN LORENZO, NORZAGARAY, BULACAN	VI-TDS-1 TO VI-TDS-3

## SECTION III – TECHNICAL SPECIFICATIONS

### PART II – TECHNICAL DATA SHEETS

#### REHABILITATION/RESTORATION OF DAM INSTRUMENTATIONS OF ANGAT DAM MAIN AND SECONDARY DYKES LOCATED IN SAN LORENZO, NORZAGARAY, BULACAN.

##### Technical Requirements

- a. The Bidder shall complete this technical data sheet and submit the filled-up form with the technical proposal. The Bidder shall use continuation sheets as necessary for any other additional information keeping to the format shown herein or by reproducing the same.
- b. NPC reserves the right to reject Bids without proper and/or specific data and information as required herein.
- c. The data required are technical features and characteristics of the Equipment/component/material to be provided by the bidder. Bidder's proposal shall at least be equal or superior to the requirements specified by NPC.

ITEM	DESCRIPTION	REQUIREMENTS	SUPPLIER'S DATA
<b>1.0</b>	<b>DATA LOGGER</b>		
	1. Manufacturer	By Supplier	
	2. Place of Manufacture	By Supplier	
	3. Brand/Model	By Supplier	
	4. Quantity	By Supplier	
	5. Pressure Range	600 kPa	
	6. Output	0-5V, 10mV/v	
	7. Accuracy	<0.1% F.S.	
	8. Operating Temperature	80°C	
	9. Data Logger		
	a. Channel Capacity	At least 3	
	b. Accuracy	±0.05%	
	c. Operating Temperature	50°C	
	d. Scan Interval	24 hours	
	e. Interface	10-Pin Connector, 6-Pin Waterproof Connector, RS-232/USB/RS-485	
	10. Solar Power System		
	a. Capacity	310W c/w Mounting Kits	
	b. MPPT Solar Charge Controller	20 A	
	c. Deep Cycle Battery	150AH, NPD Deep Cycle	
	d. Solar Cable	Twin-core, 15-meters x 4mm <sup>2</sup>	
<b>2.0</b>	<b>IP COMMUNICATION RADIO SYSTEM</b>		
	1. Manufacturer	By Supplier	
	2. Place of Manufacture	By Supplier	
	3. Brand/Model	By Supplier	
	4. Quantity	By Supplier	
	5. Type	By Supplier	
	6. Power Supply	PoE	
	7. Antenna Gain	25 dBi	
	8. Antenna Feed	Dish Reflector	
	9. Protection	IP55	
	10. Wind Survival	145 kph	
	11. LED Indicator	Power, Ethernet, Signal	

Name of Firm

Name &amp; Signature of Representative

Designation

ITEM	DESCRIPTION	REQUIREMENTS	SUPPLIER'S DATA
		Strength Indicator	
	12. Operating Temperature	60°C	
	13. Frequency	5 GHz	
	14. Standards Compliance	IEC 68-2-5, IEC 68-2-14, IEC 68-2-6	
	15. Cat5e Outdoor Carrier Class Shielded Ethernet Cable	24AWG with 26AWG ESD Drain Wire, PE-outdoor rated WP jacket, L2 Multi-layered shielding	
	16. 2 x RJ45 Gigabit Ethernet Surge Suppressor	56V, Line-to-line, and line-to-ground Protection Mode (TVS Diodes)	
<b>3.0</b>	<b>INTEGRATED SOLAR LIGHT</b>		
	1. Manufacturer	By Supplier	
	2. Place of Manufacture	By Supplier	
	3. Brand/Model	By Supplier	
	4. Quantity	By Supplier	
	5. Solar Panel Parameters		
	a. Rated Power, W	110	
	b. Rated Voltage, Vdc	18	
	6. Battery Parameters		
	a. Type	LiFePO4	
	b. Rated Voltage, V	12.8	
	c. Ampacity, Ah	51	
	7. Rated Power, W	80	
	8. Charge Time, h	4	
	9. Protection	IP66	
	10. Operating Temperature deg C	0 to 60	
	11. Luminous Flux, lm	13,600	
<b>4.0</b>	<b>TESTING AND COMMISSIONING</b>		
	a. Requirement and Adjustment and Test	Perform	
	b. Commissioning and Joint Final Inspection	Perform	

Name of Firm

Name &amp; Signature of Representative

Designation

ITEM	DESCRIPTION	REQUIREMENTS	SUPPLIER'S DATA
5.0	<b>WARRANTY</b>		
	a. Warranty	To be included	
6.0	<b>SUPPORT SERVICES</b>		
	a. Warranty	To be included	

Name of Firm	Name & Signature of Representative	Designation
--------------	------------------------------------	-------------



## **SECTION IV**

# **SCHEDULE OF REQUIREMENTS**

### INSTRUCTIONS IN FILLING-UP OF DATA IN SECTION VII – SCHEDULE OF REQUIREMENTS

For items sourced from abroad, the Bidder shall only fill up the required data under the columns E (**currency shall be in US Dollar**), F, G and H for the **“Unit Price of Goods and Services to be Supplied from Abroad”** and indicate zero (0) or dash (-) under the columns I, J & K for the **“Unit Price of Goods and Related Services to be Supplied from Within the Philippines”**.

In the same manner, for items sourced locally, the Bidder shall only fill up the required data under the columns I, J & K for the **“Unit Price of Goods and Related Services to be Supplied from Within the Philippines”** and indicate zero (0) or dash (-) under the columns E, F, G and H for the **“Unit Price of Goods and Services to be Supplied from Abroad”**.

Filling up of prices for both goods and services (abroad and local portion) for the same pay item shall not allowed and will be disqualified.

The total price for the foreign sourced or the locally sourced item (whichever is the case) multiplied by the quantity shall then be indicated in column L or M respectively. For foreign sourced items with Peso portions, both the foreign portion (Column L) and Peso portion (Column M) shall be indicated in the total price.

It is further reiterated, that where a required item is provided, but no price is indicated, the same shall be considered as non-responsive, but specifying a zero (0) or dash (-) for the said item would mean that it is being offered for free to the Government, except those required by law or regulations to be provided for.

**SECTION IV - SCHEDULE OF REQUIREMENTS**  
**REHABILITATION/RESTORATION OF DAM INSTRUMENTATIONS OF ANGAT DAM MAIN AND SECONDARY**  
**DYKES LOCATED IN SAN LORENZO, NORZAGARAY, BULACAN**  
 PR No. HO-DRW23-007

ITEM NO.	Description of Work or Materials	QTY.- UNIT	* C O D E	UNIT PRICE FOR GOODS AND RELATED SERVICES TO BE SUPPLIED FROM ABROAD				UNIT PRICE FOR GOODS AND RELATED SERVICES TO BE SUPPLIED FROM WITHIN THE PHILIPPINES			TOTAL PRICE	
				Unit Price of Goods or Services Foreign Currency ( )**	Import Duties & other Levies Imposed by Phil. Govt. (Phil. Peso)	Value Added Tax and other Taxes Imposed by Phil. Govt. (Phil. Peso)	Local Transport from Port to Delivery Site *** (Phil. Peso)	Unit Price of Goods or Services (Phil. Peso)	Value Added Tax and other Taxes Imposed by Phil. Govt. (Phil. Peso)	Local Transport from Plant to Delivery Site *** (Phil. Peso)	Forex Currency (E x C)	Local Currency Portion (Phil. Peso) ((F+G+H) x C) or ((I+J+K) x C)
(A)	(B)	(C)	(D)	(E)	(F)	(G)	(H)	(I)	(J)	(K)	(L)	(M)
1.0	Rehabilitation/Restoration of Dam Instrumentations for Angat Dam Main and Secondary Dykes including all other works and services as specified in the Technical Specifications.	1 Lot										
	----- Nothing Follows -----											

Note: Final delivery site of the equipment shall be at:  
 Angat Dam, San Lorenzo, Norzagaray, Bulacan

Code	Country of Origin
US	United States

If there is a discrepancy on the numbers/units/sets/quantities between or among the technical provision and Schedule of Requirements (SOR), SOR shall prevail

- \* Bidders shall enter a code representing the Country of Origin of all imported equipment, materials and accessories
- \*\* Cost of equipment, freight, insurance, etc. up to Phil. port of entry. Refer to ITB Clause 12
- \*\*\* Unit Price for Local Transportation, insurance and other local costs incidental to delivery of the goods from the Phil port of entry to final delivery site

\_\_\_\_\_  
 Name of Bidder

\_\_\_\_\_  
 Name and Signature of Authorized Representative

\_\_\_\_\_  
 Designation





## **SECTION V**

# **BIDDING FORMS**



## SECTION V – BIDDING FORMS

### TABLE OF CONTENTS

NPCSF-GOODS-01	- Checklist of Technical and Financial Envelope Requirements for Bidders
NPCSF-GOODS-02	- List of all Ongoing Government & Private Contracts Including Contracts Awarded but not yet Started
NPCSF-GOODS-03	- Statement of the bidder's Single Largest Completed Contract (SLCC) similar to the contract to be bid
NPCSF-GOODS-04	- Computation of Net Financial Contracting Capacity (NFCC)
NPCSF-GOODS-05	- Joint Venture Agreement
<i>NPCSF-GOODS-06</i>	- <i>NOT USED</i>
NPCSF-GOODS-07	- Omnibus Sworn Statement (Revised)
NPCSF-GOODS-08	- Bid Letter
Sample Form	- Bank Guarantee Form for Advance Payment
Sample Form	- Certification from DTI as Domestic Bidder

Standard Form No: NPCSF-GOODS-01

**Checklist of Technical & Financial Envelope Requirements for Bidders**

**A. THE 1<sup>ST</sup> ENVELOPE (TECHNICAL COMPONENT) SHALL CONTAIN THE FOLLOWING:**

**1. ELIGIBILITY DOCUMENTS**

**a. (CLASS A)**

- PhilGEPs Certificate of Registration and Membership under Platinum Category (all pages) in accordance with Section 8.5.2 of the Revised IRR of RA. 9184;

**Note:** The failure by the prospective bidder to update its Certificate with the current and updated Class “A” eligibility documents shall result in the automatic suspension of the validity of its Certificate until such time that all of the expired Class “A” eligibility documents has been updated

- Statement of all its ongoing government and private contracts if any, whether similar or not similar in nature and complexity to the contract to be bid (*NPCSF-GOODS-02*)
- The Statement of the bidder’s Single Largest Completed Contract (SLCC) similar to the contract to be bid, and whose value, adjusted to current prices using the Philippine Statistics Authority (PSA) consumer price index, must be at least 25% of the ABC (*NPCSF-GOODS-03*) complete with the following supporting documents:

1. Certificate of Acceptance; or Certificate of Completion; or Official Receipt (O.R); or Sales Invoice

*(The Single Largest Completed Contract (SLCC) as declared by the bidder shall be verified and validated to ascertain such completed contract. Hence, bidders must ensure access to sites of such projects/equipment to NPC representatives for verification and validation purposes during post-qualification process.*

*It shall be a ground for disqualification, if verification and validation cannot be conducted for reasons attributable to the Bidder.)*

- Duly signed computation of its Net Financial Contracting Capacity (NFCC) at least equal to the ABC (*NPCSF-GOODS-04*) or a Committed Line of Credit (CLC) at least equal to ten percent (10%) of the ABC, issued by a Universal or Commercial Bank; If the Bidder opted to submit a Committed Line of Credit (CLC), the bidder must submit a granted credit line valid/effective at the date of bidding.

**b. (CLASS B)**

- For Joint Venture (if applicable), any of the following:
  - Valid Joint Venture Agreement (*NPCSF-GOODS-05*)

**OR**

  - Notarized statements from all the potential joint venture partners stating that they will enter into and abide by the provisions of the JVA, if awarded the contract
- Certification from the relevant government office of their country stating that Filipinos are allowed to participate in their government procurement activities for the same item/product (*For foreign bidders claiming eligibility by reason of their country’s extension of reciprocal rights to Filipinos*)

Standard Form No: NPCSF-GOODS-01

## 2. Technical Documents

- Duly signed, completely filled-out and notarized Omnibus Sworn statement (Revised) (NPCSF-GOODS-07), complete with the following attachments:
  - For Sole Proprietorship:
    - Special Power of Attorney
  - For Partnership/Corporation/Cooperative/Joint Venture:
    - Document showing proof of authorization (e.g., duly notarized Secretary's Certificate, Board/Partnership Resolution, or Special Power of Attorney, whichever is applicable)
- Drawings and documents to be submitted with the Bid/Proposal as specified in Clause TS-11.0(a) of Section III - Technical Specifications
- Complete eligibility documents of the proposed subcontractor, if any

### **B. THE 2<sup>ND</sup> ENVELOPE (FINANCIAL COMPONENT) SHALL CONTAIN THE FOLLOWING:**

- Duly signed Bid Letter indicating the total bid amount in accordance with the prescribed form (NPCSF-GOODS-08)
- Duly signed and completely filled-out Schedule of Requirement (Section IV) indicating the unit and total prices per item and the total amount in the prescribed Price Schedule form.
- For Domestic Bidder claiming for domestic preference:
  - Letter address to the BAC claiming for preference
  - Certification from DTI as Domestic Bidder in accordance with the prescribed forms provided

### **CONDITIONS:**

1. Each Bidder shall submit Two (2) copies of the first and second components of its Bid, marked Original and photocopy. Only the original copy will be read and considered for the bid. Any misplaced document outside of the Original copy will not be considered. The photocopy is ONLY FOR REFERENCE. NPC may request additional hard copies and/or electronic copies of the Bid. However, failure of the Bidders to comply with the said request shall not be a ground for disqualification..
2. A Bidder not submitting bid for reason that his cost estimate is higher than the ABC, is required to submit his letter of non-participation/regret supported by corresponding detailed estimates. Failure to submit the two (2) documents shall be understood as acts that tend to defeat the purpose of public bidding without valid reason as stated under Section 69.1.(i) of the revised IRR of R.A. 9184.

SECTION V -- BIDDING FORMS

Standard Form Number: NPCSF-GOODS-02

**List of All Ongoing Government and Private Contracts Including Contract Awarded But Not Yet Started**

Business Name : \_\_\_\_\_  
 Business Address : \_\_\_\_\_

Name of Contract/ Project Cost	a. Owner's Name b. Address c. Telephone Nos.	Nature of Work	Bidder's Role		a. Date Awarded b. Date Started c. Date of Completion or Contract Duration/ Date of Delivery	Value of Outstanding Works / Undelivered Portion
			Description	%		
Government						
Private						
Total Cost						

The bidder shall declare in this form all his on-going government and private contracts including contracts where the bidder (either as individual or as a Joint Venture) is a partner in a Joint Venture agreement other than his current joint venture where he is a partner. Non declaration will be a ground for disqualification of bid.

Note : This statement shall be supported with the following documents for all the contract(s) stated above which shall be submitted during Post-qualification:

1. Contract/Purchase Order and/or Notice of Award

Submitted by : \_\_\_\_\_  
 (Printed Name & Signature)  
 Designation : \_\_\_\_\_  
 Date : \_\_\_\_\_

SECTION V – BIDDING FORMS

Standard Form Number: NPCSF-GOODS-03

**The Statement of the bidder’s Single Largest Completed Contract (SLCC) similar to the contract to be bid**

Business Name : \_\_\_\_\_  
 Business Address : \_\_\_\_\_

Name of Contract	a. Owner's Name b. Address c. Telephone Nos.	Nature of Work	Contractor's Role		a. Amount at Award b. Amount at Completion c. Duration	a. Date Awarded b. Contract Effectivity c. Date Completed
			Description	%		

- Notes: 1. The bidder must state only one (1) Single Largest Completed Contract (SLCC) similar to the contract to be bid.  
 2. Supporting documents such as any of the following: Certificate of Acceptance; or Certificate of Completion; or Official Receipt (O.R); or Sales Invoice for the contract stated above shall be submitted during Bid Opening.

Submitted by : \_\_\_\_\_  
 (Printed Name & Signature)  
 Designation : \_\_\_\_\_  
 Date : \_\_\_\_\_

Standard Form Number: NPCSF-GOODS-04

**NET FINANCIAL CONTRACTING CAPACITY (NFCC)**

- A. Summary of the Supplier's/Distributor's/Manufacturer's assets and liabilities on the basis of the income tax return and audited financial statement for the immediately preceding calendar year are:

		Year 20__
1.	Total Assets	
2.	Current Assets	
3.	Total Liabilities	
4.	Current Liabilities	
5.	Net Worth (1-3)	
6.	Net Working Capital (2-4)	

- B. The Net Financial Contracting Capacity (NFCC) based on the above data is computed as follows:

NFCC = [(Current assets minus current liabilities) x 15] minus the value of all outstanding or uncompleted portions of the projects under ongoing contracts, including awarded contracts yet to be started coinciding with the contract for this Project.

NFCC = P \_\_\_\_\_

Herewith attached is certified true copy of the audited financial statement, stamped "RECEIVED" by the BIR or BIR authorized collecting agent for the immediately preceding calendar year.

Submitted by:

\_\_\_\_\_  
Name of Supplier / Distributor / Manufacturer

\_\_\_\_\_  
Signature of Authorized Representative

Date : \_\_\_\_\_

Standard Form Number: NPCSF-GOODS-05

### JOINT VENTURE AGREEMENT

**KNOW ALL MEN BY THESE PRESENTS:**

That this JOINT VENTURE AGREEMENT is entered into by and between: \_\_\_\_\_, of legal age, *(civil status)* \_\_\_\_\_, authorized representative of \_\_\_\_\_ and a resident of \_\_\_\_\_.

- and –

\_\_\_\_\_, of legal age, *(civil status)* \_\_\_\_\_, authorized representative of \_\_\_\_\_ a resident of \_\_\_\_\_.

That both parties agree to join together their capital, manpower, equipment, and other resources and efforts to enable the Joint Venture to participate in the Bidding and Undertaking of the hereunder stated Contract of the **National Power Corporation**.

**NAME OF PROJECT**

**CONTRACT AMOUNT**

That the capital contribution of each member firm:

NAME OF FIRM	CAPITAL CONTRIBUTION
1.	<b>P</b>
2.	<b>P</b>

That both parties agree to be jointly and severally liable for their participation in the Bidding and Undertaking of the said contract.

That both parties agree that \_\_\_\_\_ and/or \_\_\_\_\_ shall be the Official Representative/s of the Joint Venture, and are granted full power and authority to do, execute and perform any and all acts necessary and/or to represent the Joint Venture in the Bidding and Undertaking of the said contract, as fully and effectively and the Joint Venture may do and if personally present with full power of substitution and revocation.

That this Joint Venture Agreement shall remain in effect only for the above stated Contract until terminated by both parties.

\_\_\_\_\_  
*Name & Signature of Authorized Representative*

\_\_\_\_\_  
*Official Designation*

\_\_\_\_\_  
*Name of Firm*

\_\_\_\_\_  
*Name & Signature of Authorized Representative*

\_\_\_\_\_  
*Official Designation*

\_\_\_\_\_  
*Name of Firm*

*Witnesses*

1. \_\_\_\_\_ 2. \_\_\_\_\_

**[Jurat]**

*[Format shall be based on the latest Rules on Notarial Practice]*



Standard Form No: NPCSF-GOODS-07

### Omnibus Sworn Statement (Revised)

REPUBLIC OF THE PHILIPPINES )  
CITY/MUNICIPALITY OF \_\_\_\_\_ ) S.S.

#### AFFIDAVIT

I, [Name of Affiant], of legal age, [Civil Status], [Nationality], and residing at [Address of Affiant], after having been duly sworn in accordance with law, do hereby depose and state that:

1. *[Select one, delete the other:]*

*[If a sole proprietorship:]* I am the sole proprietor or authorized representative of [Name of Bidder] with office address at [address of Bidder];

*[If a partnership, corporation, cooperative, or joint venture:]* I am the duly authorized and designated representative of [Name of Bidder] with office address at [address of Bidder];

2. *[Select one, delete the other:]*

*[If a sole proprietorship:]* As the owner and sole proprietor, or authorized representative of [Name of Bidder], I have full power and authority to do, execute and perform any and all acts necessary to participate, submit the bid, and to sign and execute the ensuing contract for [Name of the Project] of the [Name of the Procuring Entity], as shown in the attached duly notarized Special Power of Attorney;

*[If a partnership, corporation, cooperative, or joint venture:]* I am granted full power and authority to do, execute and perform any and all acts necessary to participate, submit the bid, and to sign and execute the ensuing contract for [Name of the Project] of the [Name of the Procuring Entity], as shown in the attached [state title of attached document showing proof of authorization (e.g., duly notarized Secretary's Certificate, Board/Partnership Resolution, or Special Power of Attorney, whichever is applicable:)];

3. [Name of Bidder] is not "blacklisted" or barred from bidding by the Government of the Philippines or any of its agencies, offices, corporations, or Local Government Units, foreign government/foreign or international financing institution whose blacklisting rules have been recognized by the Government Procurement Policy Board, by itself or by relation, membership, association, affiliation, or controlling interest with another blacklisted person or entity as defined and provided for in the Uniform Guidelines on Blacklisting;

4. Each of the documents submitted in satisfaction of the bidding requirements is an authentic copy of the original, complete, and all statements and information provided therein are true and correct;

5. [Name of Bidder] is authorizing the Head of the Procuring Entity or its duly authorized representative(s) to verify all the documents submitted;

6. *[Select one, delete the rest:]*

*[If a sole proprietorship:]* The owner or sole proprietor is not related to the Head of the Procuring Entity, members of the Bids and Awards Committee (BAC), the Technical Working Group, and the BAC Secretariat, the head of the Project Management Office or the end-user unit, and the project consultants by consanguinity or affinity up to the third civil degree;

*[If a partnership or cooperative:]* None of the officers and members of *[Name of Bidder]* is related to the Head of the Procuring Entity, members of the Bids and Awards Committee (BAC), the Technical Working Group, and the BAC Secretariat, the head of the Project Management Office or the end-user unit, and the project consultants by consanguinity or affinity up to the third civil degree;

*[If a corporation or joint venture:]* None of the officers, directors, and controlling stockholders of *[Name of Bidder]* is related to the Head of the Procuring Entity, members of the Bids and Awards Committee (BAC), the Technical Working Group, and the BAC Secretariat, the head of the Project Management Office or the end-user unit, and the project consultants by consanguinity or affinity up to the third civil degree;

7. *[Name of Bidder]* complies with existing labor laws and standards; and
8. *[Name of Bidder]* is aware of and has undertaken the responsibilities as a Bidder in compliance with the Philippine Bidding Documents, which includes:
  - a. Carefully examining all of the Bidding Documents;
  - b. Acknowledging all conditions, local or otherwise, affecting the implementation of the Contract;
  - c. Making an estimate of the facilities available and needed for the contract to be bid, if any; and
  - d. Inquiring or securing Supplemental/Bid Bulletin(s) issued for the *[Name of the Project]*.
9. *[Name of Bidder]* did not give or pay directly or indirectly, any commission, amount, fee, or any form of consideration, pecuniary or otherwise, to any person or official, personnel or representative of the government in relation to any procurement project or activity.
10. In case advance payment was made or given, failure to perform or deliver any of the obligations and undertakings in the contract shall be sufficient grounds to constitute criminal liability for Swindling (Estafa) or the commission of fraud with unfaithfulness or abuse of confidence through misappropriating or converting any payment received by a person or entity under an obligation involving the duty to deliver certain goods or services, to the prejudice of the public and the government of the Philippines pursuant to Article 315 of Act No. 3815 s. 1930, as amended, or the Revised Penal Code.

**IN WITNESS WHEREOF**, I have hereunto set my hand this \_\_\_ day of \_\_\_, 20\_\_\_ at \_\_\_\_\_, Philippines.

*[Insert NAME OF BIDDER OR ITS AUTHORIZED REPRESENTATIVE]*

*[Insert signatory's legal capacity]*

Affiant

**[Jurat]**

*[Format shall be based on the latest Rules on Notarial Practice]*

Standard Form No: NPCSF-GOODS-08

**BID LETTER**

Date: \_\_\_\_\_

To: **THE PRESIDENT**  
National Power Corporation  
Gabriel Y. Itchon Building  
Sen. Miriam P. Defensor-Santiago Blvd.  
(formerly BIR Road) corner Quezon Avenue  
Diliman, Quezon City, Philippines 1100

Gentlemen:

Having examined the Bidding Documents including Bid Bulletin Numbers *[insert numbers]*\_\_\_\_\_, the receipt of which is hereby duly acknowledged, we, the undersigned, offer to perform **REHABILITATION / RESTORATION OF DAM INSTRUMENTATIONS OF ANGAT DAM MAIN AND SECONDARY DYKES LOCATED IN SAN LORENZO, NORZAGARAY, BULACAN (PR NO. HO-DRW23-007)** in conformity with the said Bidding Documents for the sum of *[total Bid amount in words and figures]*\_\_\_\_\_ or such other sums as may be ascertained in accordance with the Schedule of Prices attached herewith and made part of this Bid.

We undertake, if our Bid is accepted, to supply and deliver the goods and perform other services, if required within the contract duration and in accordance with the scope of the contract specified in the Schedule of Requirements and Technical Specifications.

If our Bid is accepted, we undertake to provide a performance security in the form, amounts, and within the times specified in the Bidding Documents.

We agree to abide by this Bid for the Bid Validity Period specified in Bid Documents and it shall remain binding upon us and may be accepted at any time before the expiration of that period.

Until a formal Contract is prepared and executed, this Bid, together with your written acceptance thereof and your Notice of Award, shall be binding upon us.

We understand that you are not bound to accept the Lowest Calculated Bid or any Bid you may receive.

We certify/confirm that we comply with the eligibility requirements pursuant to the Bidding Documents.

We likewise certify/confirm that the undersigned, *[for sole proprietorships, insert: as the owner and sole proprietor or authorized representative of [Name of Bidder]*\_\_\_\_\_ has the full power and authority to participate, submit the bid, and to sign and execute the ensuing contract, on the latter's behalf for the *[Name of Project]*\_\_\_\_\_ of the National Power Corporation *[for partnerships, corporations, cooperatives, or joint ventures, insert: is granted full power and authority by the [Name of Bidder]*\_\_\_\_\_ to participate, submit the bid, and to sign and execute the ensuing contract on the latter's behalf for *[Name of Project]*\_\_\_\_\_ of the National Power Corporation.

We acknowledge that failure to sign each and every page of this Bid Letter, including the attached Schedule of Requirements (Bid Price Schedule), shall be a ground for the rejection of our bid.

\_\_\_\_\_  
*[name and signature of authorized signatory]*\_\_\_\_\_  
*[in the capacity of]*Duly authorized to sign Bid for and on behalf of \_\_\_\_\_  
*[name of bidder]*

---

**Bank Guarantee Form for Advance Payment**

---

To: **THE PRESIDENT**  
National Power Corporation  
Gabriel Y. Itchon Building  
Sen. Miriam P. Defensor-Santiago Blvd.  
(formerly BIR Road) corner Quezon Avenue  
Diliman, Quezon City, Philippines 1100

*[name of Contract]*

Gentlemen and/or Ladies:

In accordance with the Advance Payment Provision, of the General Conditions of Contract, *[name and address of Supplier]* (hereinafter called the "Supplier") shall deposit with the PROCURING ENTITY a bank guarantee to guarantee its proper and faithful performance under the said Clause of the Contract in an amount of *[amount of guarantee in figures and words]*.

We, the *[name of the universal/commercial bank]*, as instructed by the Supplier, agree unconditionally and irrevocably to guarantee as primary obligator and not as surety merely, the payment to the PROCURING ENTITY on its first demand without whatsoever right of objection on our part and without its first claim to the Supplier, in the amount not exceeding *[amount of guarantee in figures and words]*.

We further agree that no change or addition to or other modification of the terms of the Contract to be performed thereunder or of any of the Contract documents which may be made between the PROCURING ENTITY and the Supplier, shall in any way release us from any liability under this guarantee, and we hereby waive notice of any such change, addition, or modification.

This guarantee shall remain valid and in full effect from the date the advance payment is received by the Supplier under the Contract and until the Goods are accepted by the PROCURING ENTITY.

Yours truly,

Signature and seal of the Guarantors

\_\_\_\_\_  
*[name of bank or financial institution]*

\_\_\_\_\_  
*[address]*

\_\_\_\_\_  
*[date]*

**CERTIFICATION AS A DOMESTIC BIDDER**

This is to certify that based on the records of this office, (Name of Bidder) is  
duly registered with the DTI on \_\_\_\_\_.

This further certifies that the articles forming part of the product of (Name of Bidder),  
which are/is (Specify), are substantially composed of  
articles, materials, or supplies grown, produced or manufactured in the Philippines. (Please  
encircle the applicable description/s).

This certification is issued upon the request of (Name of Person/Entity) in  
connection with his intention to participate in the bidding for the (Name of Project)  
of the National Power Corporation (NPC).

Given this \_\_\_ day of \_\_\_\_\_ 20\_\_ at \_\_\_\_\_, Philippines

\_\_\_\_\_  
Name

\_\_\_\_\_  
Position

\_\_\_\_\_  
Department of Trade & Industry

# SECTION VI

# REFERENCE DRAWINGS

**SECTION VI – REFERENCE DRAWINGS****EW – ELECTRICAL WORKS**

<b>DRAWING NO.</b>	<b>TITLE</b>
AgtDAM-BDE-22.001	STRONG MOTION ACCELEROMETER SYSTEM ARCHITECTURE
AgtDAM-BDE-22.002	STRONG MOTION ACCELEROMETER INSTALLATION DETAILS
AgtDAM-BDE-22.003	STANDPIPE PIEZOMETER SYSTEM ARCHITECTURE
AgtDAM-BDE-22.004	DATA LOGGER AND COMMUNICATION SYSTEM FOR STANDPIPE PIEZOMETER STATION
AgtDAM-BDE-22.005	INSTRUMENTATION NETWORK DIAGRAM

SOLAR PV MODULE

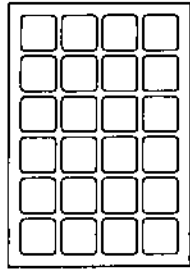

DC CURRENT ▼

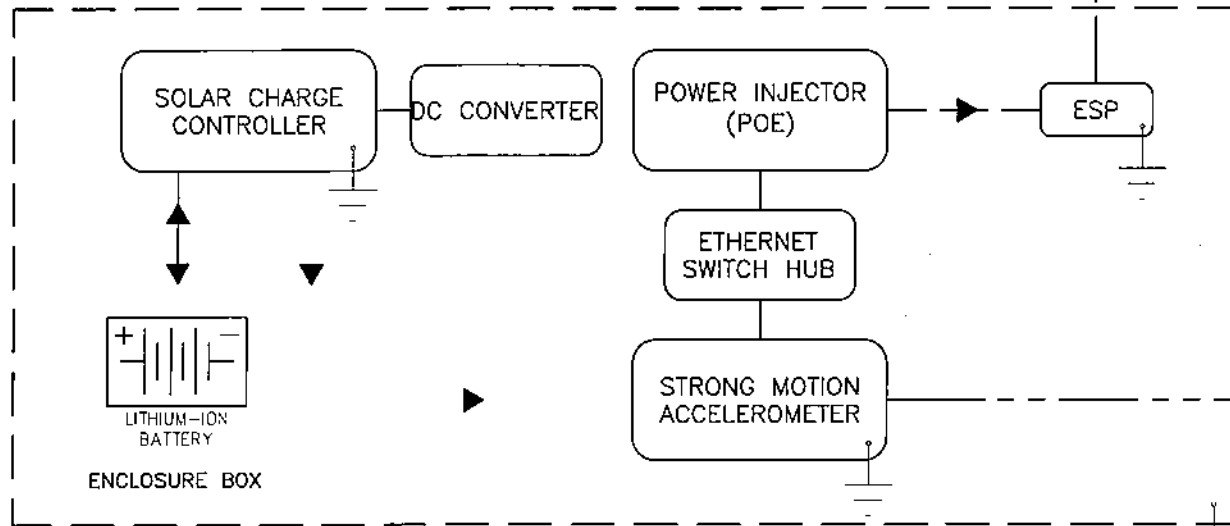

**STRONG MOTION ACCELEROMETER SYSTEM ARCHITECTURE**

**NOTES:**

1. ALL ELECTRICAL WORKS SHALL BE DONE IN ACCORDANCE WITH THE LATEST PROVISIONS OF THE PHILIPPINE ELECTRICAL CODE AND SHALL COMPLY WITH THE RULES AND REGULATIONS OF THE LOCAL CODES AND STANDARDS.
2. ALL EQUIPMENT/COMPONENTS/MODEM, ETC. NOT INDICATED IN THE DRAWING BUT ARE REQUIRED FOR THE EFFICIENT AND PROPER OPERATION OF THE SYSTEM SHALL BE INCLUDED IN THE CONTRACTOR SCOPE OF WORK AT NO ADDITIONAL COST TO NPC.
3. THE CONTRACTOR IS REQUIRED TO CONDUCT SITE INSPECTION AND ASSESS THE EXTENT OF THE WORKS NEEDED TO IMPLEMENT THE PROJECT COMPLETELY AND EFFICIENTLY.
4. THIS DRAWING IS CONCEPTUAL AND FOR BIDDING PURPOSES ONLY. THE SUPPLIER SHALL IDENTIFY THE FINAL SINGLE LINE DIAGRAM OF THE SYSTEM INCLUDING ITS INTERNAL CIRCUITRY AND PRIMARY COMPONENTS CONNECTION.
5. THE DETAILED DESIGN AND CALCULATION FOR THE REQUIRED NUMBER OF EQUIPMENT FOR INSTALLATION SHALL BE SUBMITTED FOR NPC'S REVIEW AND APPROVAL.

**LEGENDS:**

- ESP — ETHERNET SURGE PROTECTOR
- GPS — GLOBAL POSITIONING SYSTEM
- POE — POWER OVER ETHERNET
- — POWER CABLE
- - - - - COMMUNICATION CABLE

OWNER:		 <b>NATIONAL POWER CORPORATION</b> GABRIEL Y. ITCHON BLDG., SEN. MIRAM P. DEFENSOR-SANTIAGO AVENUE (FORMERLY BIR ROAD) CORNER QUEZON AVENUE, DULAMAN 1100 QUEZON CITY, PHILIPPINES	
PROJECT:		REHABILITATION/RESTORATION OF DAM INSTRUMENTATIONS OF ANGE DAM MAIN AND SECONDARY DYKES LOCATED IN SAN LORENZO NORZAGARAY, BULACAN	
LOCATION:		Ange Dam, San Lorenzo, Norzagaray, Bulacan	
TITLE:		<b>STRONG MOTION ACCELEROMETER SYSTEM ARCHITECTURE</b>	
DESIGNED	RRPR	DATE	SUBMITTED: <i>[Signature]</i> R.P. VERAR
DRAWN	RRPR		
REVIEWED	PRINCIPAL ENGR./ARCHT.		RECOMMENDED: <i>[Signature]</i> G.Z. MAGPOC, JR. Engr. EECO
CIVIL/ARCHT			APPROVED: <i>[Signature]</i> G.B. MAGPOC, JR. Manager, EDC
ELEC.			
MECH.			
DWG. NO. <b>AgIDAM-BDE-22.001</b>		SPECS. NO. PR NO. HO-DRW23-007	
SCALE: NTS		REFERENCE DRAWING	
REV.	DATE	NATURE OF REVISION	BY
			CHKD.
			RECD.
			APPD.



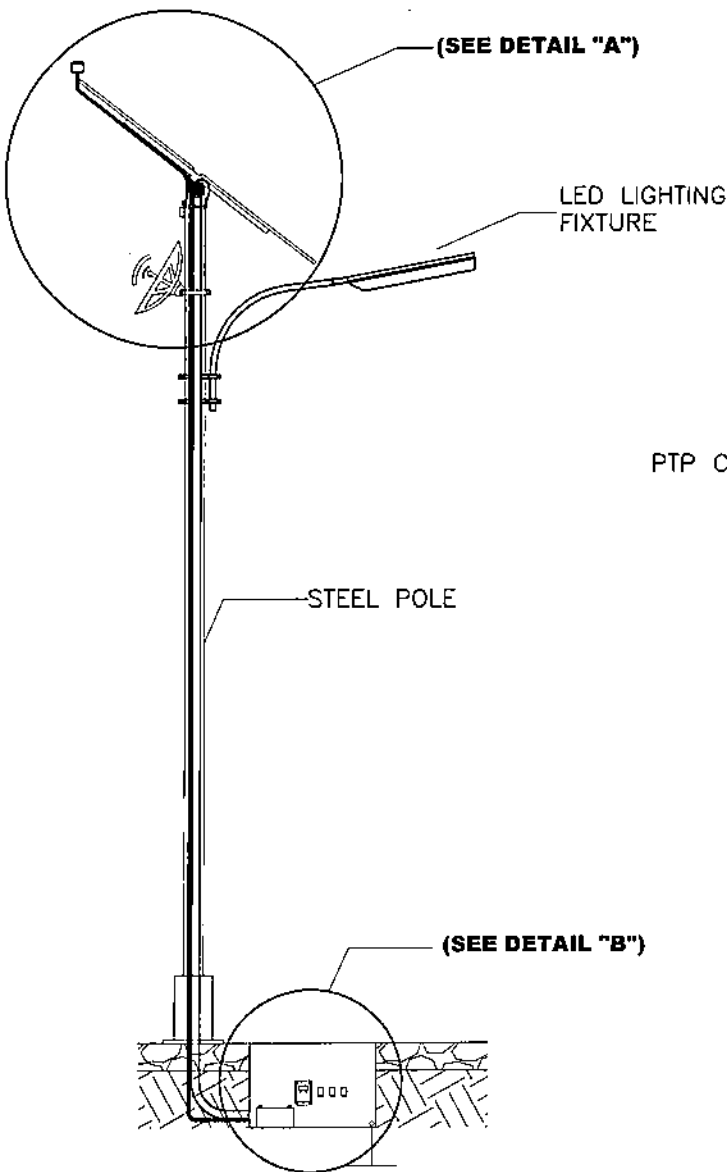

**STRONG MOTION ACCELEROMETER  
INSTALLATION DETAILS**

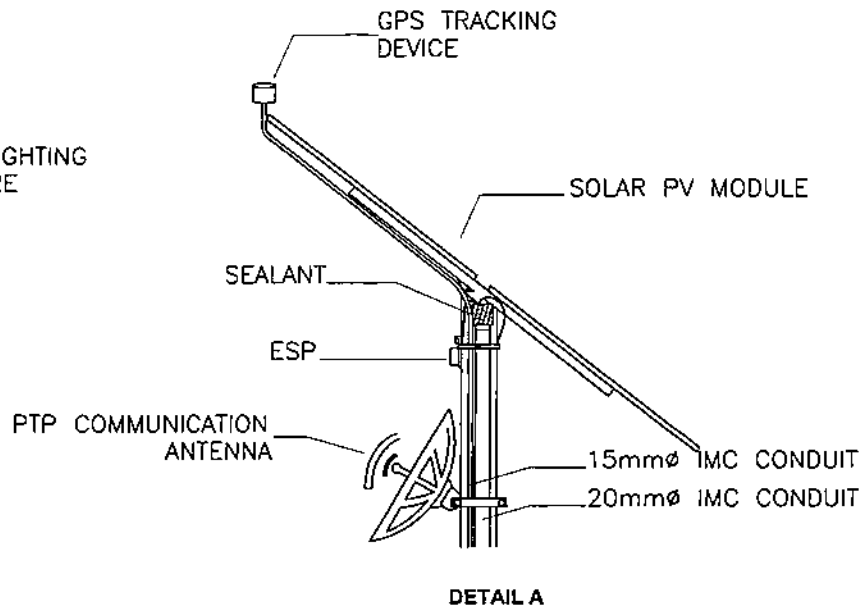

**DETAIL A**

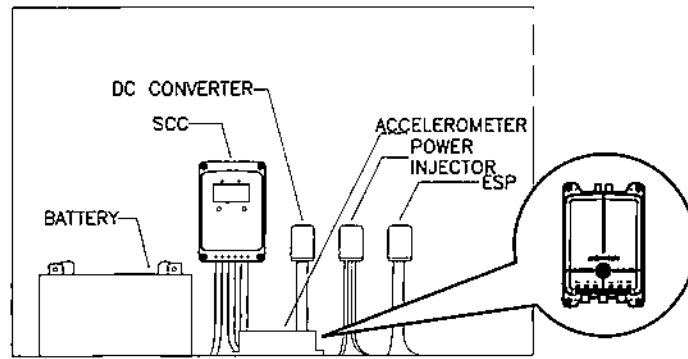





**DETAIL B**

**NOTES:**

1. FINAL EQUIPMENT INSTALLATION LOCATIONS SHALL BE DETERMINED AS PER ACTUAL SITE SITUATION AND SYSTEM REQUIREMENT.
2. ALL EQUIPMENT/COMPONENTS/MODEM, ETC. NOT INDICATED IN THE DRAWING BUT ARE REQUIRED FOR THE EFFICIENT AND PROPER OPERATION OF THE SYSTEM SHALL BE INCLUDED IN THE CONTRACTOR SCOPE OF WORK AT NO ADDITIONAL COST TO NPC.
3. THE CONTRACTOR IS REQUIRED TO CONDUCT SITE INSPECTION AND ASSESS THE EXTENT OF THE WORKS NEEDED TO IMPLEMENT THE PROJECT COMPLETELY AND EFFICIENTLY.
4. THE SYSTEM TO BE BUILT SHALL BE COMPATIBLE WITH THE CURRENT SYSTEM UTILIZED ON SITE.
5. ALL EQUIPMENT TO BE SUPPLIED SHALL BE SUBMITTED TO NPC FOR REVIEW AND APPROVAL.

**LEGENDS:**

- ESP — ETHERNET SURGE PROTECTOR
- GPS — GLOBAL POSITIONING SYSTEM
- SCC — SOLAR CHARGE CONTROLLER

OWNER:		 <b>NATIONAL POWER CORPORATION</b> GABRIEL Y. ITCHON BLDG., SEN. MIRIAM P. DEFENSOR-SANTIAGO AVENUE (FORMERLY BIR ROAD) CORNER QUEZON AVENUE, DILIMAN 1100 QUEZON CITY, PHILIPPINES	
PROJECT:		REHABILITATION/RESTORATION OF DAM INSTRUMENTATIONS OF ANGA DAM MAIN AND SECONDARY DYKES LOCATED IN SAN LORENZO NORZAGARAY, BULACAN	
LOCATION:		Angat Dam, San Lorenzo, Norzagaray, Bulacan	
TITLE: <b>STRONG MOTION ACCELEROMETER INSTALLATION DETAILS</b>			
DESIGNED	BY	CHKD	DATE
DRAWN	RRPR		
REVIEWED	PRINCIPAL ENGR./ARCHT.		
CIVIL/ARCHT			
ELEC.			
MECH.			
SUBMITTED:		 R.P. VERAR Electrical Engineer	
RECOMMENDED:		 G.Z.C. LUDOD, JR. Manager, ESDO	
APPROVED:		 G.B. MAGPOC, JR. Manager, ESDO	

DWG. NO. **AgDAM-BDE-22.002** SPEC. NO. PR NO. HO-DRW23-007

REV.	DATE	NATURE OF REVISION	BY	CHKD.	RECD.	APPD.

SCALE: NTS      REFERENCE DRAWING      REV. 0

SOLAR PV MODULE

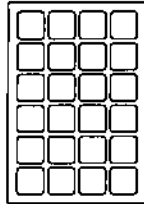

DC CURRENT ▼

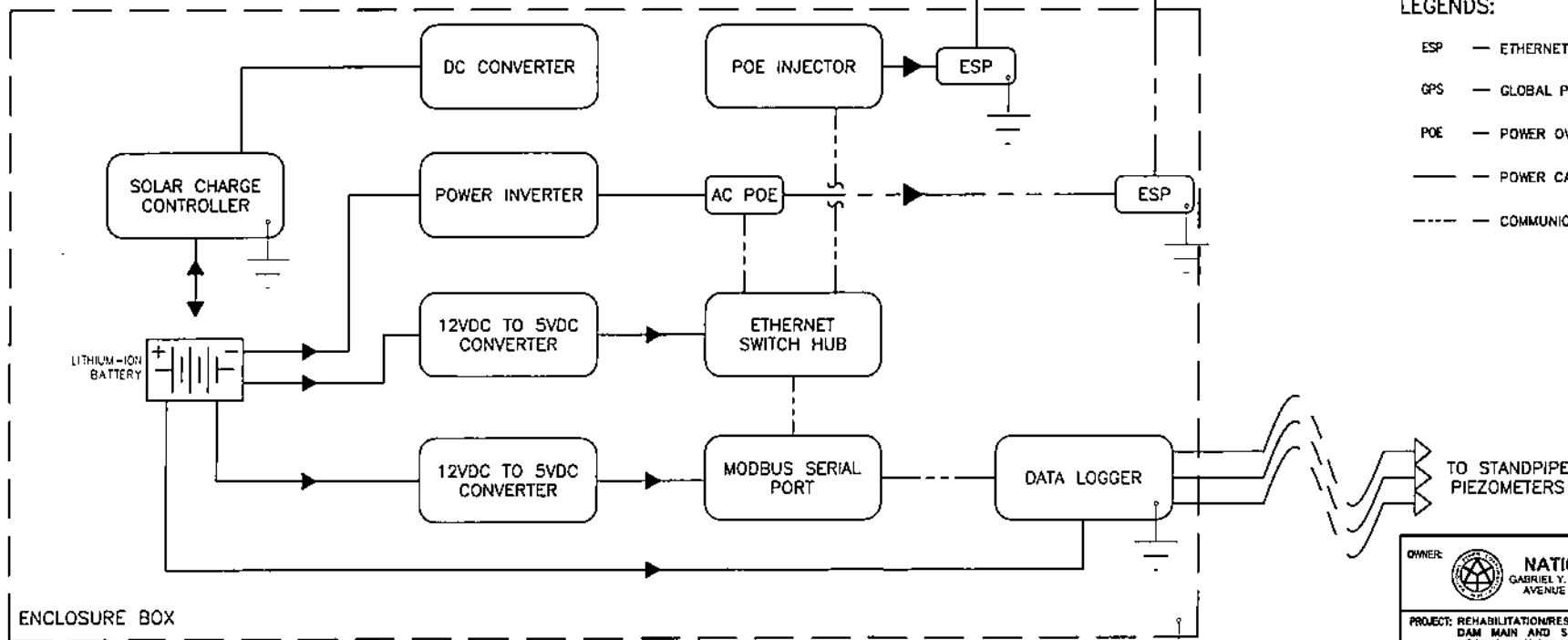

NOTES:

1. ALL ELECTRICAL WORKS SHALL BE DONE IN ACCORDANCE WITH THE LATEST PROVISIONS OF THE PHILIPPINE ELECTRICAL CODE AND SHALL COMPLY WITH THE RULES AND REGULATIONS OF THE LOCAL CODES AND STANDARDS.
2. ALL EQUIPMENT/COMPONENTS/MODEM, ETC. NOT INDICATED IN THE DRAWING BUT ARE REQUIRED FOR THE EFFICIENT AND PROPER OPERATION OF THE SYSTEM SHALL BE INCLUDED IN THE CONTRACTOR SCOPE OF WORK AT NO ADDITIONAL COST TO NPC.
3. THE CONTRACTOR IS REQUIRED TO CONDUCT SITE INSPECTION AND ASSESS THE EXTENT OF THE WORKS NEEDED TO IMPLEMENT THE PROJECT COMPLETELY AND EFFICIENTLY.
4. THIS DRAWING IS CONCEPTUAL AND FOR BIDDING PURPOSES ONLY. THE SUPPLIER SHALL IDENTIFY THE FINAL SINGLE LINE DIAGRAM OF THE SYSTEM INCLUDING ITS INTERNAL CIRCUITRY AND PRIMARY COMPONENTS CONNECTION.
5. THE DETAILED DESIGN AND CALCULATION FOR THE REQUIRED NUMBER OF EQUIPMENT FOR INSTALLATION SHALL BE SUBMITTED FOR NPC'S REVIEW AND APPROVAL.

LEGENDS:

- ESP — ETHERNET SURGE PROTECTOR
- GPS — GLOBAL POSITIONING SYSTEM
- POE — POWER OVER ETHERNET
- — POWER CABLE
- - - - COMMUNICATION CABLE

STANDPIPE PIEZOMETER SYSTEM ARCHITECTURE

OWNER:		<b>NATIONAL POWER CORPORATION</b> GABRIEL Y. ITCHIM BLDG., SEN. MIRIAM P. DEFENSOR-SANTIAGO AVENUE (FORMERLY BIR ROAD) CORNER QUEZON AVENUE, DILIMAN 1100 QUEZON CITY, PHILIPPINES	
PROJECT: REHABILITATION/RESTORATION OF DAM INSTRUMENTATIONS OF ANGA DAM MAIN AND SECONDARY DYKES LOCATED IN SAN LORENZO NORZAGARAY, BULACAN			
LOCATION: Angat Dam, San Lorenzo, Norzagaray, Bulacan			
TITLE: <b>STANDPIPE PIEZOMETER SYSTEM ARCHITECTURE</b>			
DESIGNED	RRPR	CHKD	DATE
DRAWN	RRPR		
REVIEWED	PRINCIPAL ENGR. / ARCHT.		
CIVIL ARCHT			
ELEC.			
MECH.			
SUBMITTED:		 <b>R.P. VERAR</b> Manager, E&C	
RECOMMENDED:		 <b>C.Z. LUGOD, JR.</b> Manager, E&C	
APPROVED:		 <b>G.B. MAGDOC, JR.</b> Manager, E&C	
DWG. NO. <b>AgtDAM-BDE-22.003</b>		SPEC. NO. PR NO. HO-DW23-007	
SCALE: NTS		REFERENCE DRAWING	
REV. 0			

REV.	DATE	NATURE OF REVISION	BY	CHKD.	RECD.	APPD.

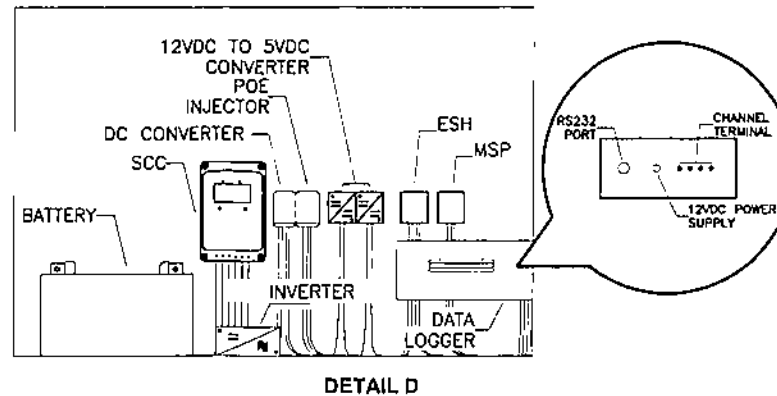
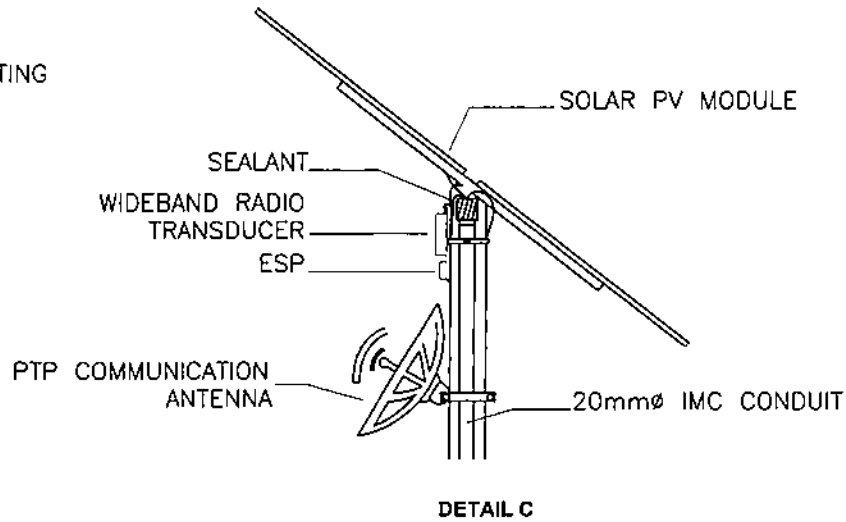
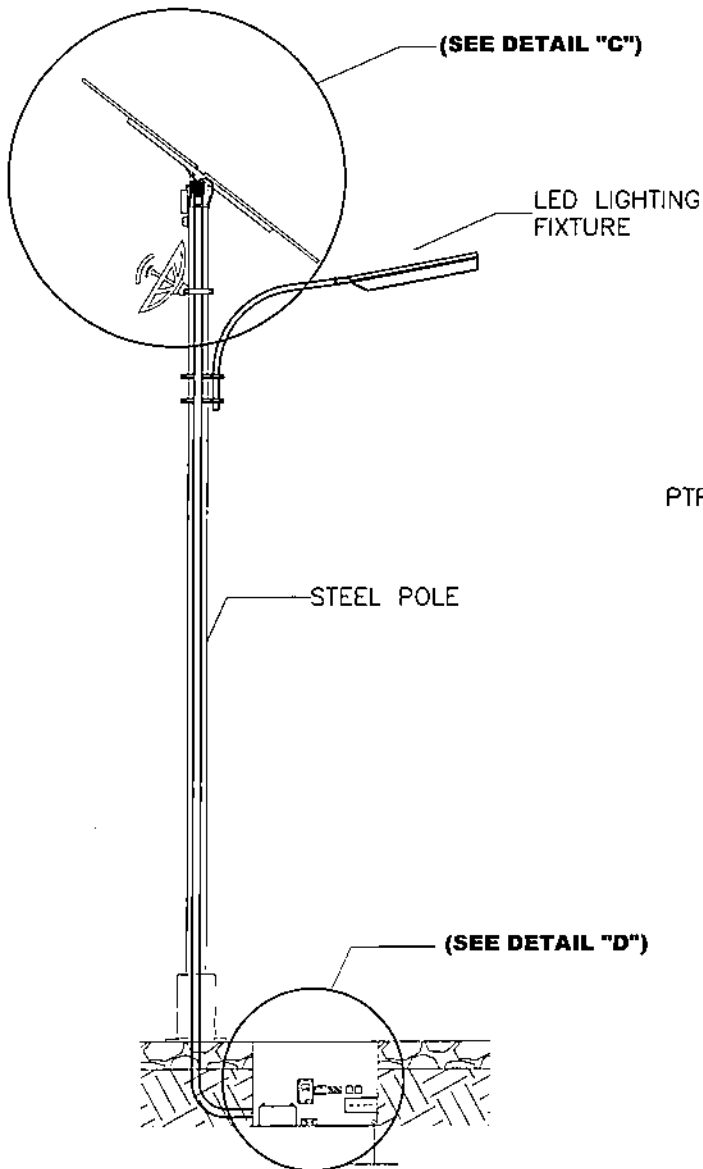





DATA LOGGER AND COMMUNICATION EQUIPMENT SYSTEM FOR STANDPIPE PIEZOMETER STATION

NOTES:

1. FINAL EQUIPMENT INSTALLATION LOCATIONS SHALL BE DETERMINED AS PER ACTUAL SITE SITUATION AND SYSTEM REQUIREMENT.
2. ALL EQUIPMENT/COMPONENTS/MODEM, ETC. NOT INDICATED IN THE DRAWING BUT ARE REQUIRED FOR THE EFFICIENT AND PROPER OPERATION OF THE SYSTEM SHALL BE INCLUDED IN THE CONTRACTOR SCOPE OF WORK AT NO ADDITIONAL COST TO NPC.
3. THE CONTRACTOR IS REQUIRED TO CONDUCT SITE INSPECTION AND ASSESS THE EXTENT OF THE WORKS NEEDED TO IMPLEMENT THE PROJECT COMPLETELY AND EFFICIENTLY.
4. THE SYSTEM SHALL BE COMPATIBLE WITH THE EXISTING SYSTEM AVAILABLE ON SITE.
5. ALL EQUIPMENT TO BE SUPPLIED SHALL BE SUBMITTED TO NPC FOR REVIEW AND APPROVAL.

LEGENDS:

- ESP — ETHERNET SURGE PROTECTOR
- GPS — GLOBAL POSITIONING SYSTEM
- ESH — ETHERNET SWITCH HUB
- MSP — MODBUS SERIAL PORT
- AC POE — ALTERNATING CURRENT POWER OVER ETHERNET
- DC POE — DIRECT CURRENT POWER OVER ETHERNET
- SCC — SOLAR CHARGE CONTROLLER

OWNER		 <b>NATIONAL POWER CORPORATION</b> GABRIEL Y. ITCHON BLDG., SEN. MARIAMP. DEFENSOR-SANTIAGO AVENUE (FORMERLY BIR ROAD) CORNER QUEZON AVENUE, DULAMAN 1103 QUEZON CITY, PHILIPPINES	
PROJECT: REHABILITATION/RESTORATION OF DAM INSTRUMENTATIONS OF ANGA DAM MAIN AND SECONDARY DYKES LOCATED IN SAN LORENZO NORZAGARAY, BULACAN			
LOCATION: Angat Dam, San Lorenzo, Norzagaray, Bulacan			
TITLE: <b>DATA LOGGER COMMUNICATION SYSTEM FOR STANDPIPE PIEZOMETER STATION</b>			
DESIGNED	BY: RPR	CHKD	DATE
DRAWN	BY: RPR		
REVIEWED	PRINCIPAL ENGR./ARCHT.		
CIVIL/ARCHT			
ELEC.			
MECH.			
SUBMITTED:		 <b>R. P. VERAR</b> Electrical Engineer, ECE	
RECOMMENDED:		 <b>E. Z. C. LUGOD, JR.</b> Member, ESEC	
APPROVED:		 <b>G. B. MAGPOC, JR.</b> Manager, EEO	
DWG. NO. <b>AgtDAM-3DE-22.004</b>		SPECS. NO. PR NO. HO-DRW23-007	
SCALE: NTS		REFERENCE DRAWING	
REV.	DATE	NATURE OF REVISION	BY
			CHKD.
			RECD.
			APPD.
			REV. <b>0</b>

NOTES:

1. FINAL EQUIPMENT INSTALLATION LOCATIONS SHALL BE DETERMINED AND COORDINATED WITH THE END-USER.
2. ALL EQUIPMENT/COMPONENTS/MODEM, ETC. NOT INDICATED IN THE DRAWING BUT ARE REQUIRED FOR THE EFFICIENT AND PROPER OPERATION OF THE SYSTEM SHALL BE INCLUDED IN THE CONTRACTOR SCOPE OF WORK AT NO ADDITIONAL COST TO NPC.
3. THE CONTRACTOR IS REQUIRED TO CONDUCT SITE INSPECTION AND ASSESS THE EXTENT OF THE WORKS NEEDED TO IMPLEMENT THE PROJECT COMPLETELY AND EFFICIENTLY.
4. THE SYSTEM TO BE BUILT SHALL BE COMPATIBLE WITH THE CURRENT SYSTEM UTILIZED ON SITE.
5. ALL EQUIPMENT TO BE SUPPLIED SHALL BE SUBMITTED TO NPC FOR REVIEW AND APPROVAL.

LEGENDS:

- SMA — SMA STATION
- SPP — SPP STATION
- HPP — HYDROPOWER PLANT
- WMS — WEIR MONITORING SYSTEM
- — WIRELESS SIGNAL TO ANGAT HYDROPOWER PLANT
- — WIRELESS SIGNAL TO ANGAT GUEST HOUSE
- - - - — WIRELESS SIGNAL TO SMA/SPP
- ~ — LAN DATA CABLE

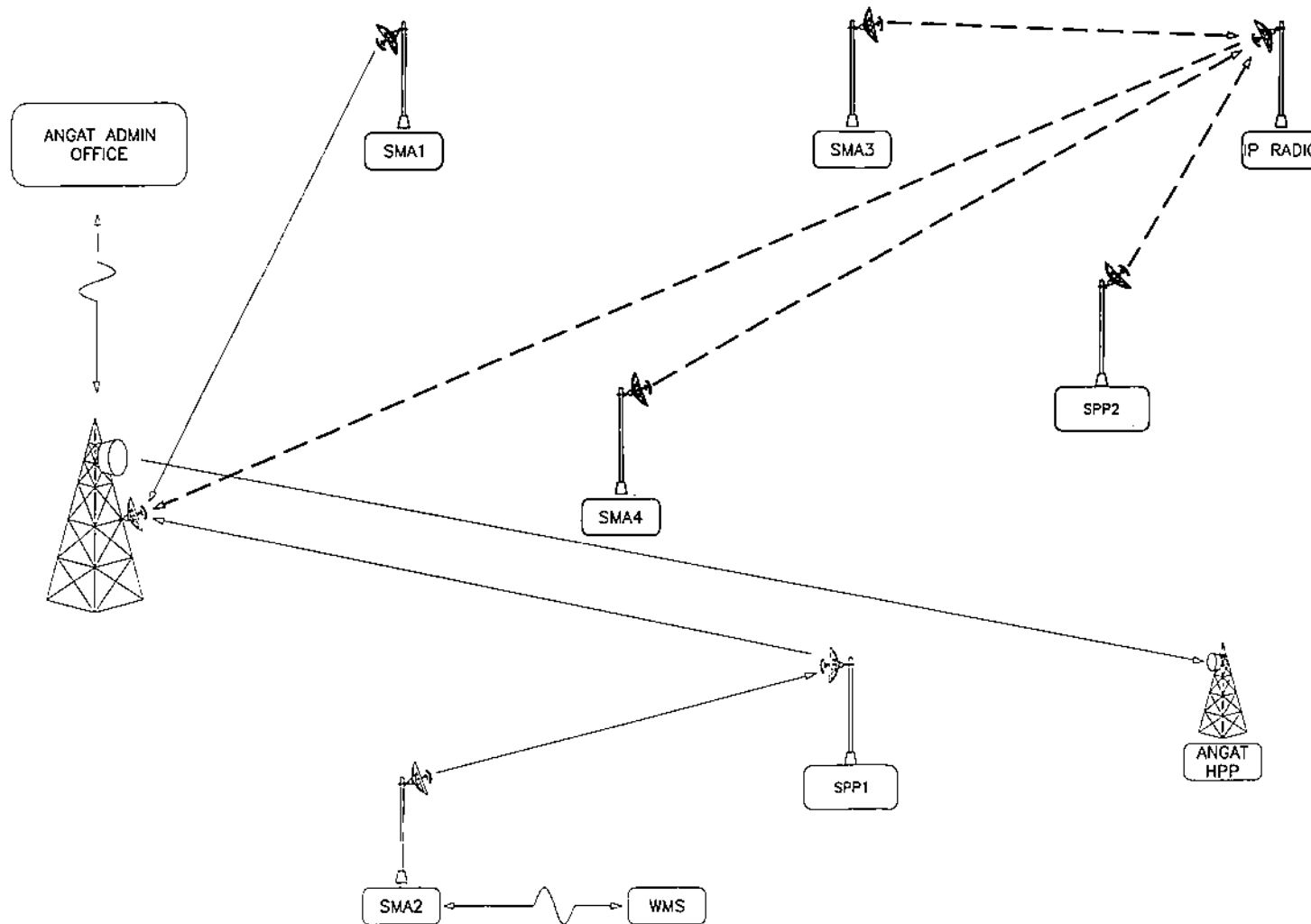

OWNER:	 <b>NATIONAL POWER CORPORATION</b> GABRIEL Y. ITCHON BLDG., 8th FLOOR, DEFENSOR-SANTIAGO AVENUE (FORMERLY BIR ROAD), CORNER QUEZON AVENUE, DILIMAN 1105 QUEZON CITY, PHILIPPINES		
PROJECT:	REHABILITATION/RESTORATION OF DAM INSTRUMENTATIONS OF ANGAT DAM MAIN AND SECONDARY DYKES LOCATED IN SAN LORENZO NORZAGARAY, BULACAN		
LOCATION:	Angat Dam, San Lorenzo, Norzagaray, Bulacan		
TITLE:	<b>INSTRUMENTATION NETWORK DIAGRAM</b>		
DESIGNED	BY	CHKD	DATE
DRAWN	RRPR		
REVIEWED	PRINCIPAL ENGR./ARCHT.		
CIVIL/ARCHT			
ELEC.			
MECH.			
SUBMITTED:	R. P. VERAR Manager, ELEC		
RECOMMENDED:	C. Z. C. LUGOD, JR. Manager, ELEC		
APPROVED:	G. B. MAGPOC, JR. Manager, ELEC		

DSG. NO. **AgDAM-BDE-22.005** SPEC. NO. PR NO. HO-DRW23-007

REV.	DATE	NATURE OF REVISION	BY	CHKD.	RECD.	APPD.

SCALE: **NTS** REFERENCE DRAWING REV. **0**